

# Youth Ever

Belong to the summer sun and young chirping girl who wears white shirt.  
Youth is the most beautiful thing which is sweet and bitter.



D014 User Manual

Notes: The product has a dustproof cover which is composed of three pieces of organic glass. Timber, cloth and bead might be slightly different between batches, please refer to the real product for detailed information.

## Lateral View



## Warm Prompt

1

### ⚠ Cautions :

Please do not allow infants and young children to play with the package for avoiding dangerous accidents!

The product must be taken out by adults and then played by children.

Children must be under the custody of adults when playing with the product

### Necessary Tools

(Tools are not included in the packing list and should be prepared by users)



### Tips for assembling

- ① Please read the user manual carefully before assembling.
- ② Firstly polish corners of wooden materials by sandpaper, and then assemble every part tidily according to Part Number.
- ③ Use tweezers to help pasting tiny materials.
- ④ Use pliers to shape iron wire.
- ⑤ Dotted lines on paper accessories are folding line, and grey parts are for pasting.
- ⑥ It is suggested to paste paper accessories by double faced adhesive tape.



# Material Bag A

(Unit: cm)

2

						A07 printed paper (at the end of the manual)	A08 glue (1 piece)
A01 medium density fiberboard (white edge) 0.5*10.5*14.6 (1 piece)	A02 medium density fiberboard (white edge + one white side) 0.5*11.7*14.1 (1 piece)	A03 medium density fiberboard (white edge + one white side) 0.5*10.5*11.7 (1 piece)	A04 organic glass 0.12*10.5*14.6 (1 piece)	A05 organic glass 0.12*11.7*14.1 (1 piece)	A06 organic glass 0.12*9.85*11.7 (1 piece)		

# Material Bag B











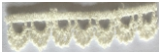

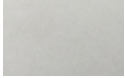

























(Unit: cm)

B01 timber block (white) 0.3*3.9*4.8 (1 piece)	B02 timber (light yellow) .2*0.5*0.7 (2 pieces)	B03 timber (light yellow) 0.2*0.5*4.6 (2 pieces)	B04 timber block (light yellow) 0.4*1.9*4.2 (4 pieces)	B05 timber (white) 0.4*0.4*8.5 (4 pieces)	B06 timber (white) 0.2*4.5*8 (2 pieces)	B07 timber (white) 0.2*0.5*8 (4 pieces)	B08 timber block (light blue) 0.3*2.3*7.8 (1 piece)
B09 timber (light blue) 0.2*1*1 (1 piece)	B10 timber (light blue) 0.2*2*4 (2 pieces)	B11 timber (light blue) 0.2*2*3.7 (3 pieces)	B12 timber (light blue) 0.2*1.7*2 (2 pieces)	B13 timber block (white) 0.2*1.5*1.5 (2 pieces)	B14 timber (white) 0.2*1.1*1.5 (2 pieces)	B15 timber (white) 0.2*1.1*1.1 (1 piece)	B16 timber block (light yellow) 0.2*1.5*1.5 (2 pieces)
B17 timber (light yellow) 0.2*1.1*1.5 (2 pieces)	B18 timber (light yellow) 0.2*1.1*1.1 (1 piece)	B19 timber (white) 0.4*2.8*5 (1 piece)	B20 timber block (light blue) 0.4*2.5*4.2 (2 pieces)	B21 timber (white) 0.2*1.3*3.8 (1 piece)	B22 timber block (light blue) 0.2*0.9*1.5 (2 pieces)	B23 timber block (light blue) 0.3*2.5*5.2 (1 piece)	B24 timber (white) 0.2*2*2.5 (1 piece)
B25 timber block (light blue) 0.3*2.3*2.5 (1 piece)	B26 timber (light yellow) 0.3*3*3.2 (1 piece)	B27 timber (white) 0.4*0.4*1.3 (4 pieces)	B28 timber (black) 0.2*1.1*1.3 (1 piece)				

# Material Bag C

(Unit: cm)

3

							
C01 white lace lenth: 6 (1 piece)	C02 light blue gauze 6*7 (1 piece)	C03 light blue ribbon length: 35 (1 piece)	C04 white paper board 12*15 (1 piece)	C05 white non-woven fabrics 10*17 (1 piece)	C06 red dotted cloth 12*17 (1 piece)	C07 red and white stripes 11*16 (1 piece)	C08 yellow cloth 7*12 (1 piece)
							
C09 white lace length:40 (1 piece)	C10 blue and white stripes 10*13 (1 piece)	C11 white lace length: 12 (1 piece)	C12 wadding (some)	C13 pink cloth with red dot 5*5 (1 piece)	C14 pink ribbon length: 25 (1 piece)	C15 white lace length:10 (1 piece)	C16 red ribbon length:14 (1 piece)
							
C17 pink and white plaids 13*15 (1 piece)	C18 white iron wire length:10 (1 piece)	C19 pink flower (2 pieces)	C20 green netted cloth 6*6 (1 piece)	C21 black iron wire length:10 (1 piece)	C22 green iron wire length:11 (1 piece)	C23 white drop-shaped bead (1 piece)	C24 silver bead chain length:16 (1 piece)
							
C25 white flower-shaped bead (3 pieces)	C26 bulb wire length: 30 (3 pieces)	C27 battery box (1 piece)	C28 gummed paper (1 piece)	C29 black screw (1 piece)	C30 sand paper (1 piece)	C31 white drop-shaped bead (1 piece)	C32 transparent flower-shaped bead (1 piece)
							
C33 transparent square bead (1 piece)	C34 red wooden bead (10 pieces)	C35 green wooden bead (10 pieces)	C36 black wooden bead (2 pieces)	C37 iron tower (1 piece)	C38 pink bead (1 piece)	C39 black bead (1 piece)	

## Instructions for Making Outer Frame

4

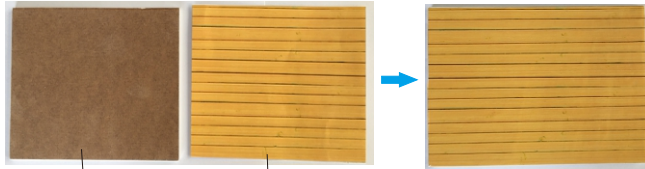

1. Take out the materials and paste the printed paper to the board.

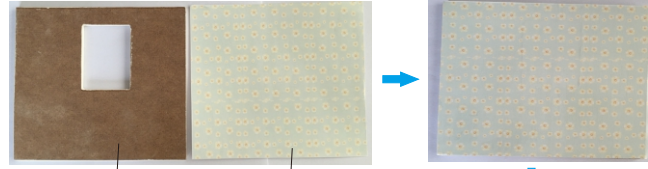
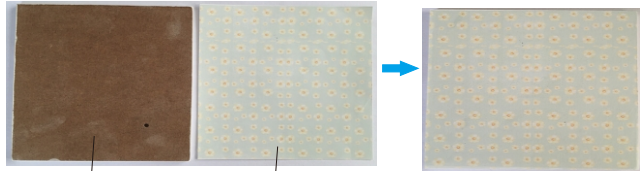

2. Take out the materials and paste the printed paper to the board.

3. After the glue is dried, cut out a hole for window with a small knife.



5. Take out the materials and paste the printed paper to the board.

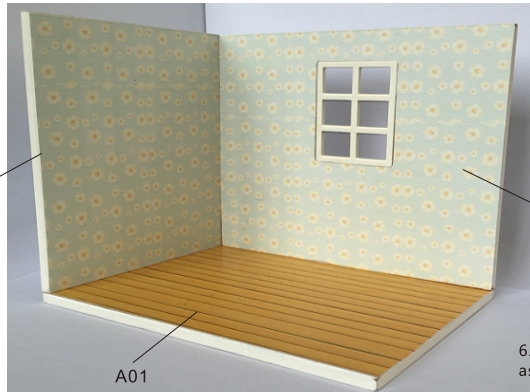

4. Take out B01 and paste it to make a window

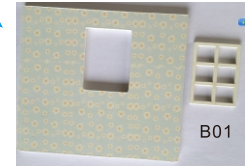

6. Paste the boards together as shown in the picture.

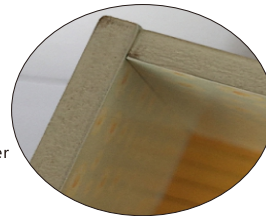

Instructions for Making Curtain

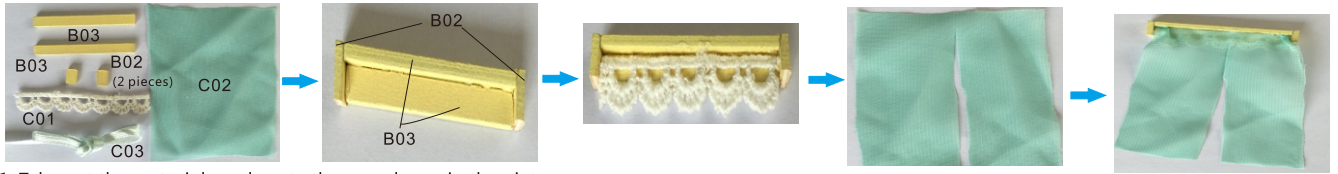

1. Take out the materials and paste them as shown in the pictures.



2. Cut out two pieces of C03 (5cm each) to tie up C02. Cut out another two pieces of C03 (10 cm each) to make two bowknots and paste them as shown in the picture.

Instructions for Making Bunk Bed

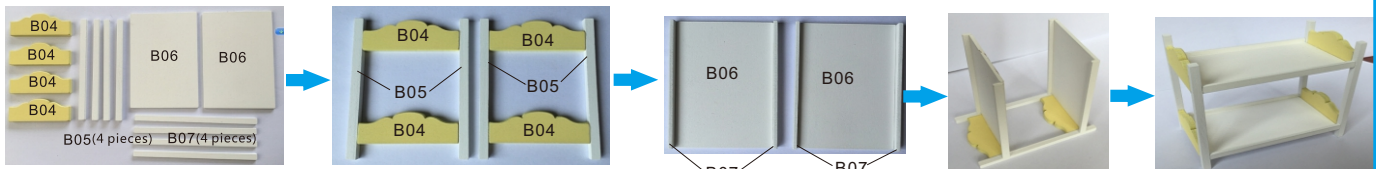

Paste the materials together to make a frame of the bed.



Paste two pieces of C05 to each paper board.

Paste C06 as shown in the picture to make two mattresses.

## Instructions for Making Bed Sheet and Pillow



C07



C07: 8x11cm (2 pieces)

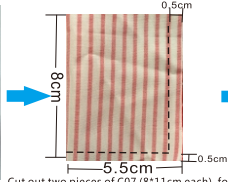

Cut out two pieces of C07 (8\*11cm each), fold one of them in half, sew it along the dotted line from the reverse side and then turn outside in.



Put the opening inside and sew it completely.



Follow the same steps to make another bed sheet

C12  
(Please provide needle and thread for yourself)

C08: 3.5x6cm

C08: 3.5x6cm

C09: 28cm



Fold it in half, and this is the reverse side of C08.

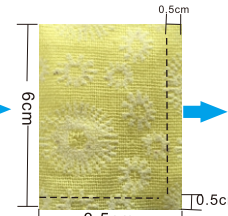

Sew it along the dotted line and then turn outside in



This is the picture after turning outside in

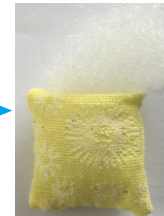

Fill it with wadding, put the opening inside (about 0.5cm) and sew it completely

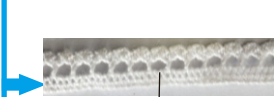
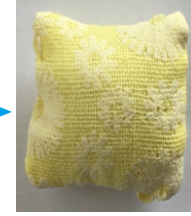

C09: 7cm (4 pieces)

Cut out four pieces of C09 (7cm each) and paste them as shown in the picture to make two yellow pillows.

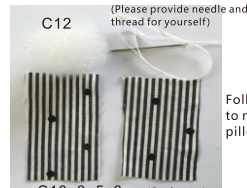
C12  
(Please provide needle and thread for yourself)

C10: 3.5x6cm (2 pieces)

Follow the same steps to make two striped pillows.

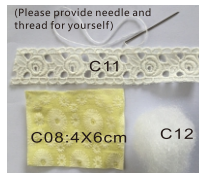

(Please provide needle and thread for yourself)

C11

C08: 4x6cm

C12

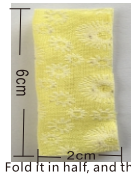

Fold it in half, and this is the reverse side of C08

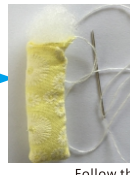

Follow the same steps to make a long pillow.



Wrap the long pillow with C11 to complete the pillow.

# Instructions for Making Cabinet and Decorations

Cabinet

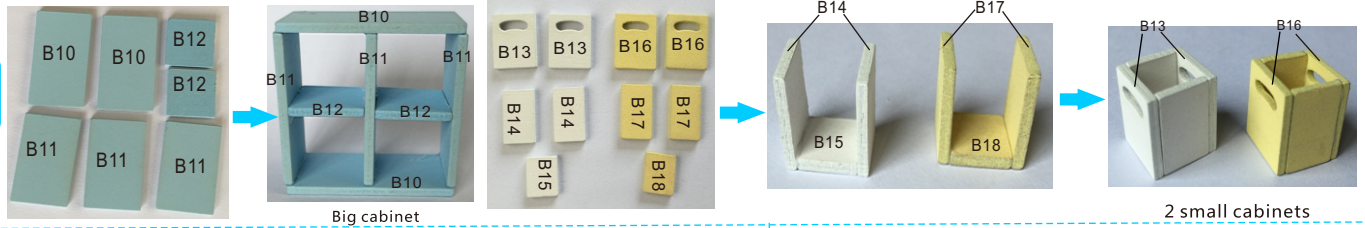
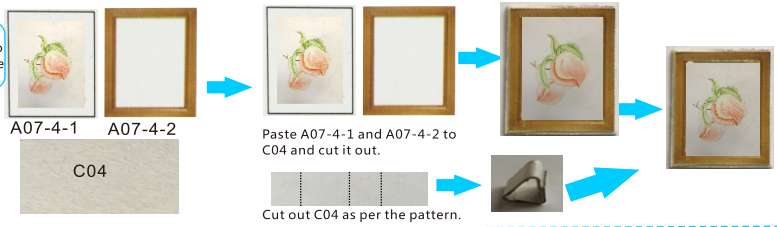
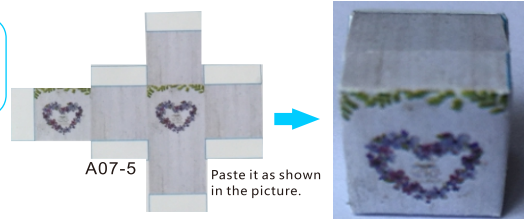

Photo Frame



Gift Box



Books



Roses

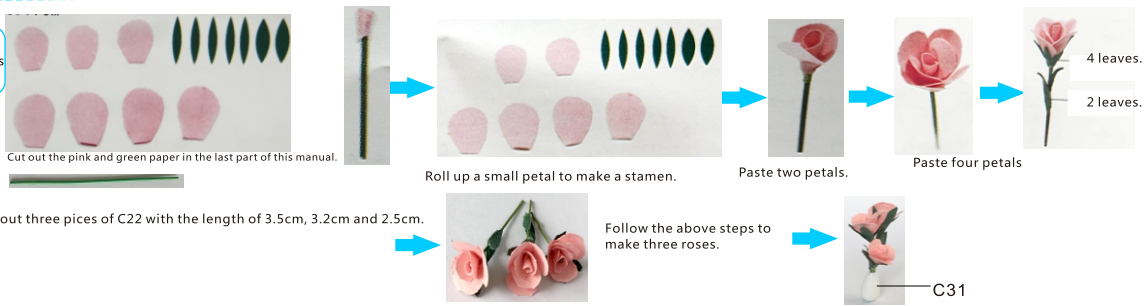



## Instructions for Making Chair and Handbag

**Chair**

**Handbag 1**

Cut out a piece of C17 as per the pattern of A07-11.

**Handbag 2**

Cut out a piece of C10 as per the pattern of A07-12.

**Books**

**Handbag 3**

Cut out a piece of C10 as per the pattern of A07-12.

Paste it as shown in the picture.

**Handbag 4**

Paste it as shown in the picture.

The reverse side

The reverse side

The reverse side

The reverse side

Paste it as shown in the picture.

Cut C15 in half, paste them to the bag and finally put A07-14 into the bag.

## Instructions for Making Table and Decorations

Table

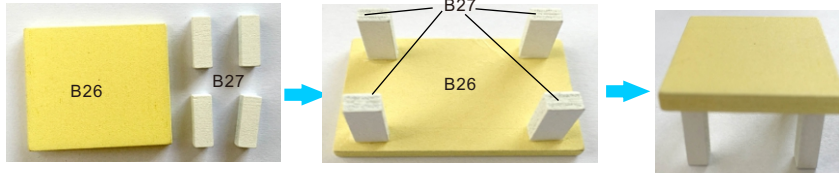

Small  
Fruit  
Basket

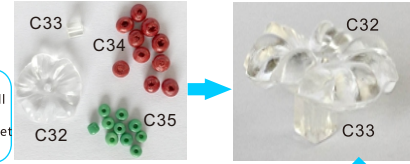

IPAD

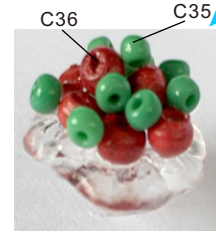
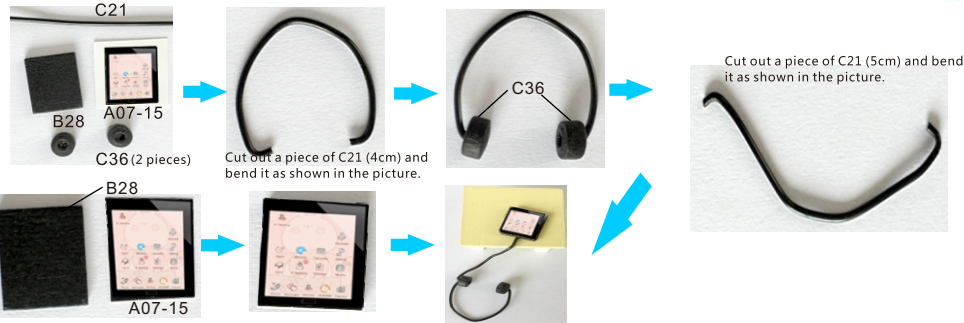

Paintings



Books



Fold and paste them as shown in the picture to make books.



As shown in the picture, paste table lamp and wall lamp in place and fix power supply wires on the wall.

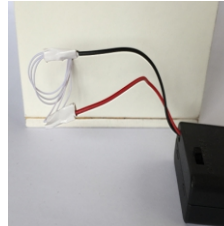
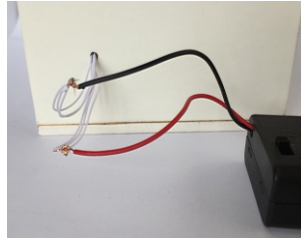
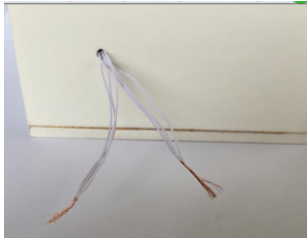

Peel off the skin from the end of each bulb wire, twist the power wires and ground wires separately and connect them to the two wires of battery box as shown in the picture and wrap the connector with gummed paper.

The connection of battery box and power supply

Cautions:

- Do not connect positive and negative terminals reversely.
- Do not put the battery in the fire.
- Do not damage outer package.
- The storage temperature should be 0~40 Celsius degree.
- Prevent it from contacting a metal or short circuit.
- Please install it strictly according to user manual.

1. Firstly connect power wires and then install batteries correctly. Peel off the skin from the end of each power wire and connect them to the battery box as shown in the diagram.



Notes: It's forbidden to touch the copper wires of power wires when power supply is connected. Please do not turn on the battery box until the copper wires are properly wrapped with gummed paper.

Wall Painting/ Wag-on-the-wall/ iPhone/ Camera

Cut out C04 as per the patterns of A07-17, 18, 19, 20, 21, 22

A07-23

Cut out A07-23 as per the pattern, fold up the model and paste them as shown in the picture.

Camera

Instructions for Making Dustproof Cover

Paste the dustproof cover as shown in the picture.

Tear off the kraft paper from each piece of glass and then paste them.

## Instructions on Making a Bowknot



1. Make a knot at the ends of the ribbon.



5. Fasten it up.



2. Press the middle position, and bend the right ribbon into a circle.



6. Trim both ends of the ribbons into expected shape to finish the bowknot.



3. Fold up the left ribbon and press it with right thumb.



4. Get left ribbon bypass right ribbon and go through the circle formed by left ribbon.



Partial Pictures

13



C37

C09



A07-26

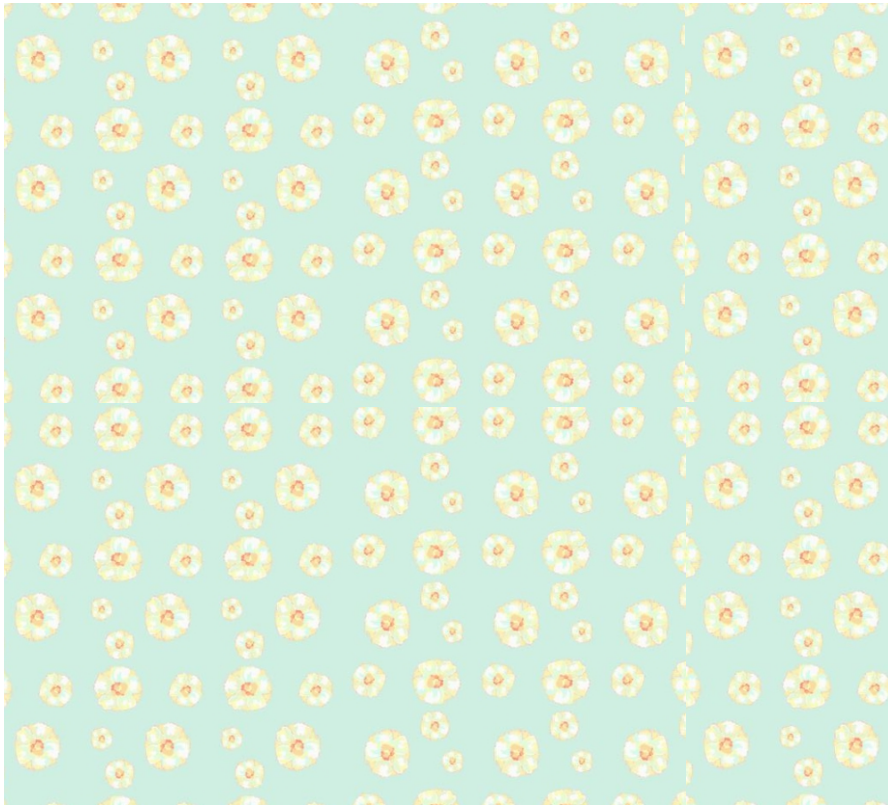

A07-3

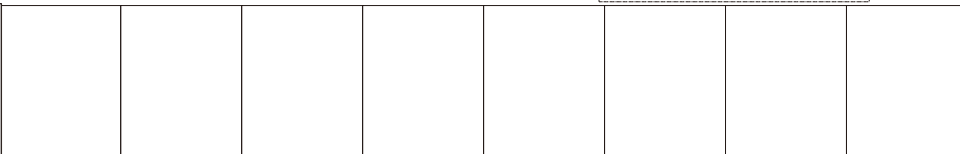
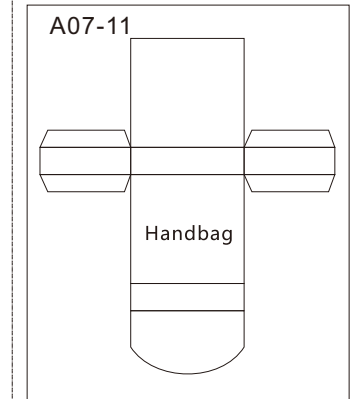
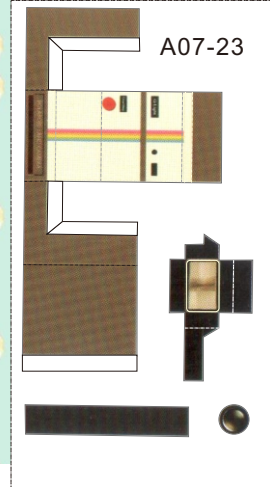
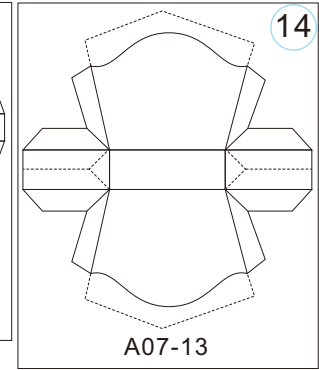
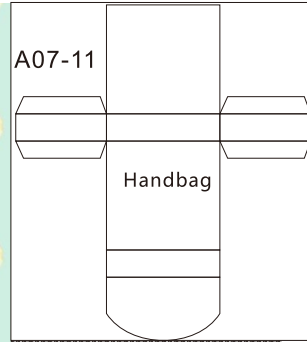

A07-25

D014 (5-1)



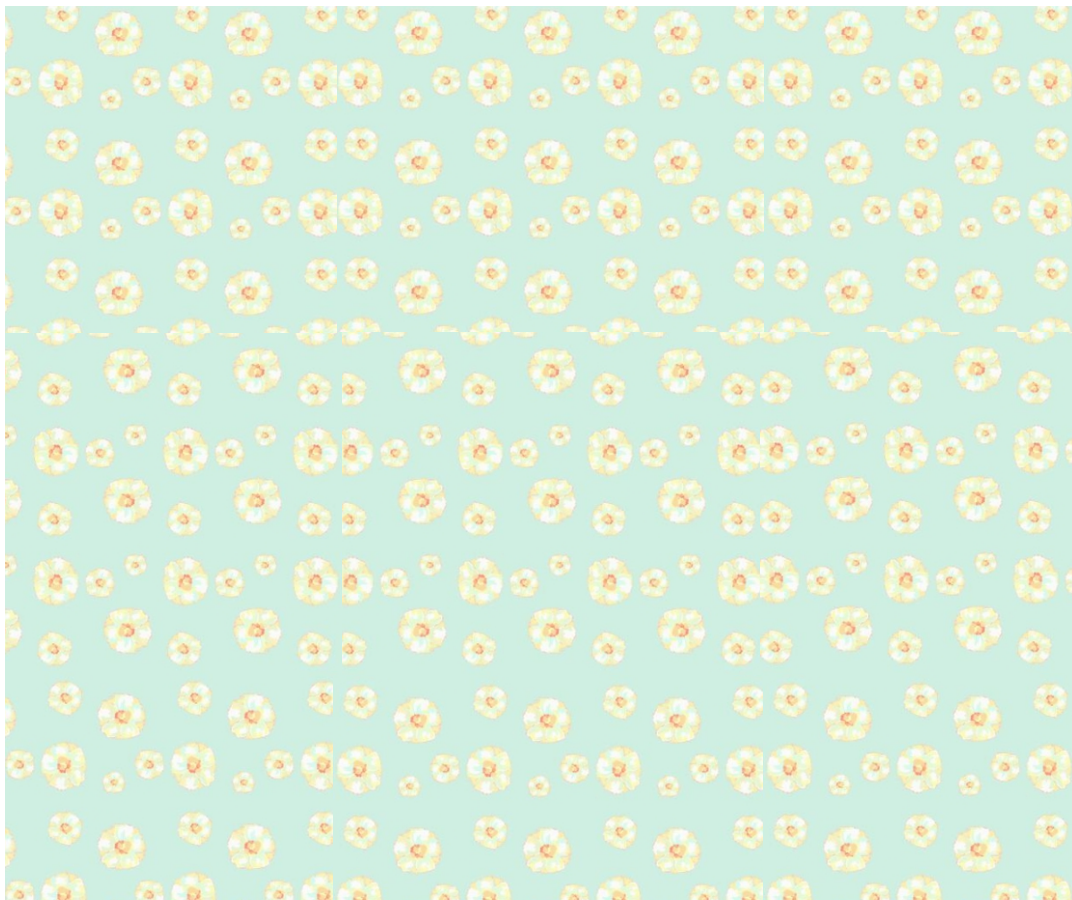

A07-2

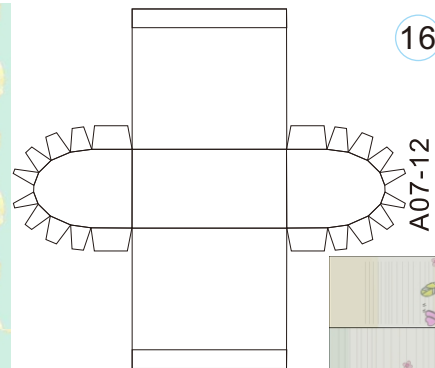

A07-12



A07-9-2

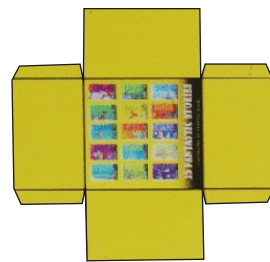

A07-9-1



A07-10

D014 (5-2)





A07-1



A07-8-2



A07-8-1

18

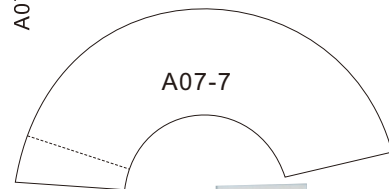

A07-7

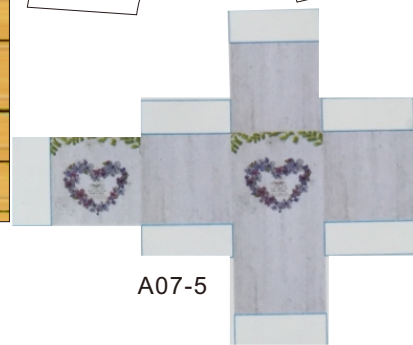

A07-5

D014 (5-3)



C04 paper board patterns

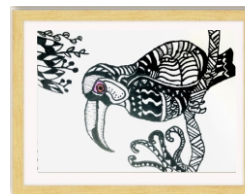
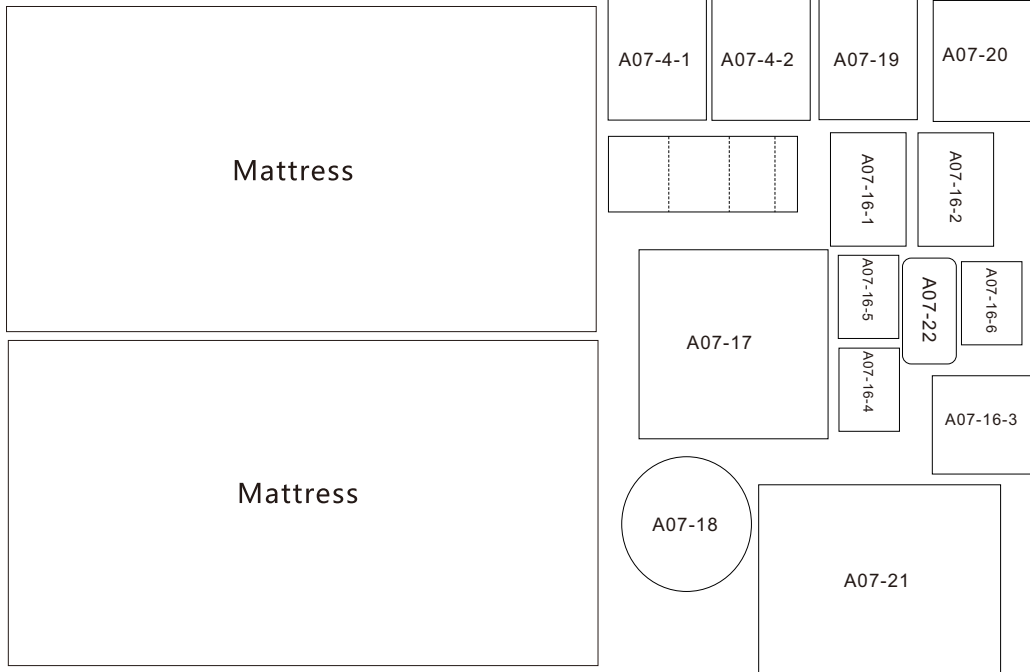

A07-21



A07-22



A07-17



A07-18

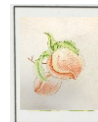

A07-4-1



A07-4-2



A07-16-1

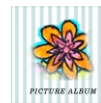

A07-16-3



A07-19



A07-16-2



A07-16-4

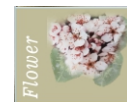

A07-20



A07-16-6

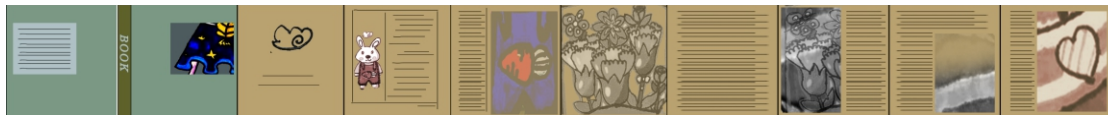

A07-14-1



A07-16-5



A07-15



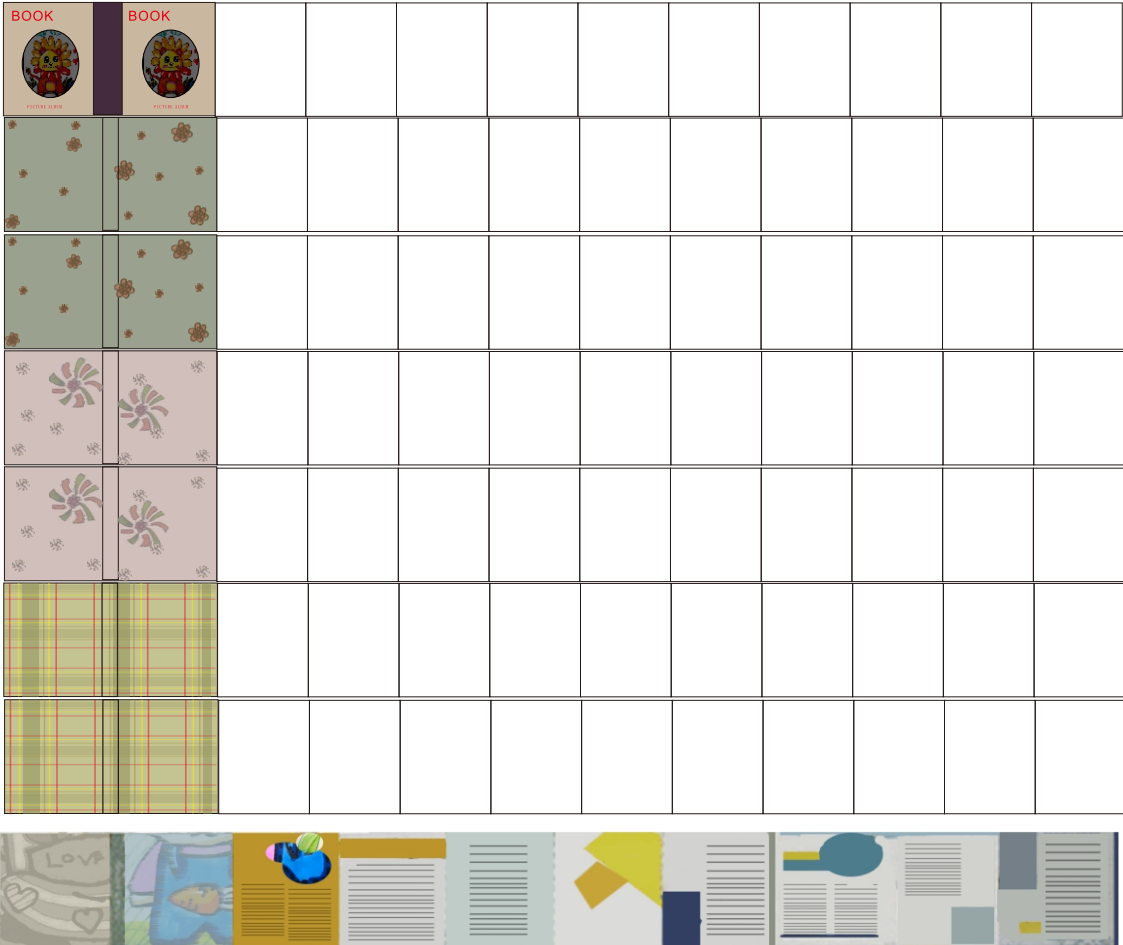

A07-6-1



22

A07-6-2



A07-26

A07-6-3

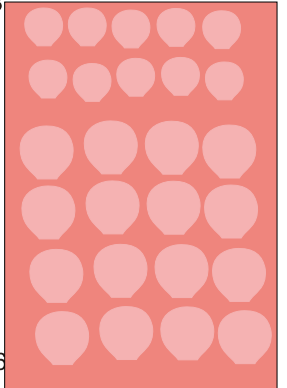

A07-6-4

A07-6-5

A07-6-6

A07-6-7

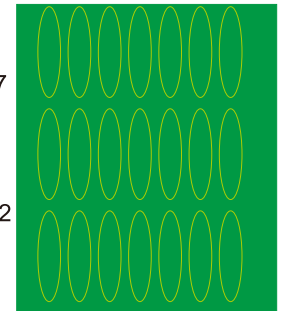

A07-14-2

