

## Dreams Come True



# NOTICE OF ASSEMBLE

## Tips for assembling

1. Because this product contains small parts, children need to use this product with an adult to avoid accidental ingestion and cause suffocation hazard. There are sharp objects in the product, be careful not to pierce people to avoid injury.
2. After all the materials are used in the required amount in the operation steps, put the remaining materials back into the original bag until the installation is completed. (Avoid losing materials during the installation process)
3. The unit of dimension marked in the step diagram is "cm".
4. Tips for making template paper: Put the template on the back of the material, fix it with some small double-sided tape, and then cut out the material to prevent the cloth or template from moving in the cutting process, or causing errors in the cut material. Or lead to insufficient materials.
5. According to the "Parts Rule Example" at the bottom of this page, refer to the parts on the part number drawing, find the actual product and compare it with the bill of materials, and then install it after confirming that it is correct. (Wooden parts only)
6. It is not advisable to apply too much glue, so as not to wait for a longer time to dry, and overflow will affect the effect of the finished product.
7. There are unavoidable small deviations in the color of wood, fabric, and beads of different batches, without notice, thanks for understanding.

## Tips for Assembling Wood



Find the corresponding block number, use a knife in the connection point gently press, you can take out the wood.

Use a knife to smooth out the burr.

Or use sandpaper to smooth out the burr

## Testing on LED function

Be sure to test the LED lights before making the lighting, note that the LED white wire to the negative, gray wire to the positive reference to the following figure operation test.

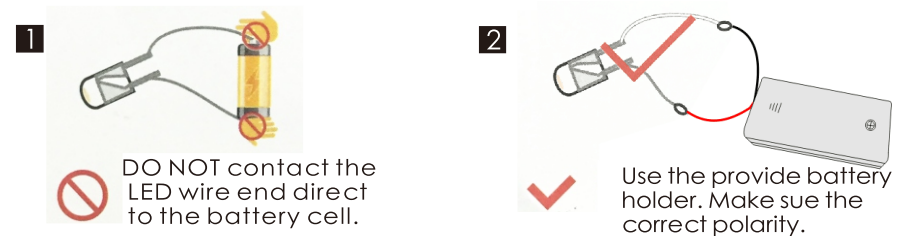

DO NOT contact the LED wire end direct to the battery cell.

Use the provide battery holder. Make sue the correct polarity.

## How to assemble the battery holder

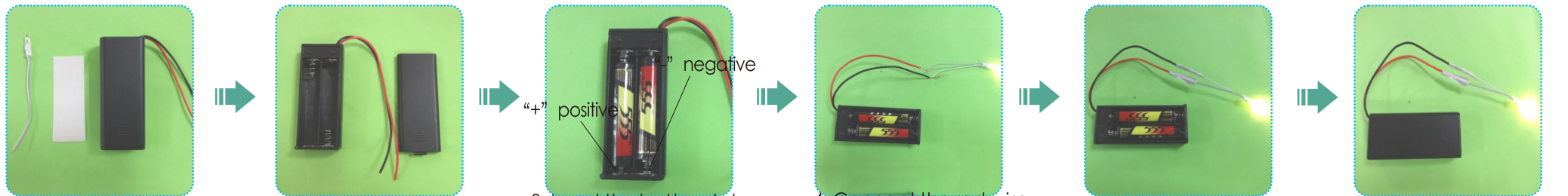

1. Material and tools needed: - Battery holder, LED bulb, tape, screw driver and 2 pieces AAA size battery(not provided)

2. Use screw driver and take the lid off from the battery holder.

3. Insert the battery take notes on the polarity.

4. Connect the red wire to grey wire. Connect the black wire to white wire.

5. Wrap the exposed wire with the tapes.

6. Place the box lid and fastness with screw driver.

## Examples of parts rule:

A01: The parts are directly in the box; B01: The parts are in the B bag; C01: The parts are in the C bag, and so on (Note: The printing paper is displayed in the step A28 - 1: The printing paper is placed directly in the box, The part number is A28 - 1. In the step, the template paper A28-N01 is displayed, A28 is the template paper, N01 is the cutting template used for the corresponding material, N01-1/N01-2 are the part numbers for the parts, and the printing paper and template paper are directly placed in the packaging box.)

# Contents

Accessory name	Material packages	
Printing paper	All of printing papers and template papers are concentrated on A28 paper accessories (total of 6 sheets of A3 and 1 sheet of A4) All of transparent printing paper accessories are concentrated on A29 (total of 1 sheet of A5)	
Dining table	Bag E+Bag L+Bag N+Bag M+printing paper	Page 3
Dining chair	Bag A+Bag E+Bag N+printing paper	Page 4
Sofa	Bag A+Bag N+printing paper	Page 4-5
Coffee table	Bag F+Bag L+Bag M+printing paper	Page 5
Desk	Bag F+Bag L+Bag N+printing paper	Page 6
Sink	Bag H+printing paper	Page 6
Bookcase	Bag A+Bag F+printing paper	Page 7
Exercise bike	Bag F+Bag M+Bag N	Page 7
Pillows	Bag N+printing paper	Page 7
European bed	Bag H+Bag N+printing paper	Page 8
Chinese bed	Bag G+Bag N+printing paper	Page 8
Chinese tables and chairs	Bag G+Bag M	Page 9
Floor lamp	Bag G+Bag L+Bag N+printing paper	Page 9
TV	Bag H+printing paper	Page 9
Side table	Bag H+Bag L+printing paper	Page 10
Bunk bed	Bag J+Bag N+printing paper	Page 10-11
Green cabinet	Bag E+Bag N+printing paper	Page 11
Screen	Bag G+printing paper	Page 11
Chandelier 1	Bag A+Bag L+Bag N+Bag P	Page 12
Chandelier 2	Bag H+Bag P	Page 12
Chandelier 3	Bag L+Bag P	Page 12
Chandelier 4	Bag L+Bag P+printing paper	Page 12
Potted plants	Bag N+printing paper	Page 12
Gate 1	Bag K+Bag M+Bag N+Bag P+printing paper	Page 13
Gate 2	Bag K+Bag N+printing paper	Page 14
Fence	Bag K	Page 14-15
Piano	Bag J+Bag N+printing paper	Page 15
Chimney	Bag D	Page 15
Lighthouse & Small spire	Bag D+Bag P	Page 16
Bird house	Bag A+Bag E+Bag P+printing paper	Page 16
Frame	Bag A+B包 +Bag C+printing paper	Page 17-28

## Thumbnail of material list (reference only)

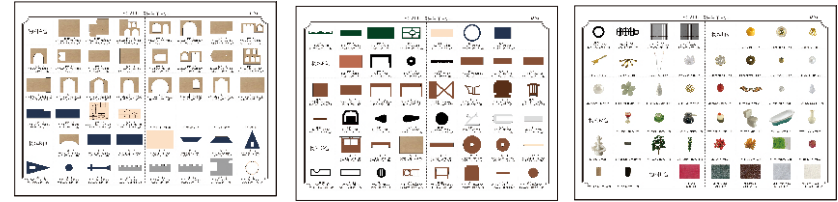

## Thumbnail of printing paper & template paper (reference only)

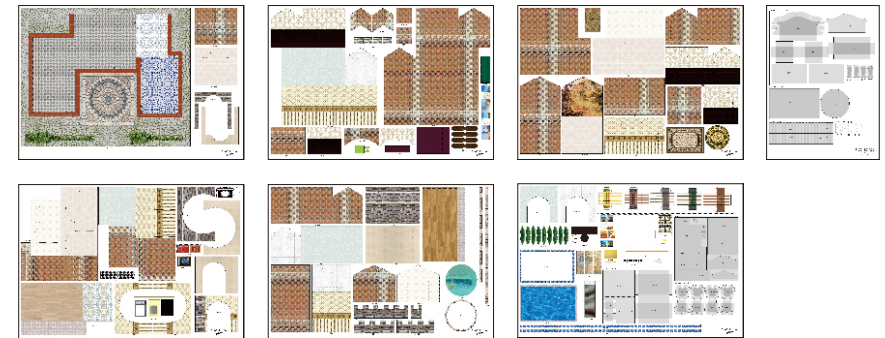

## Symbol description used

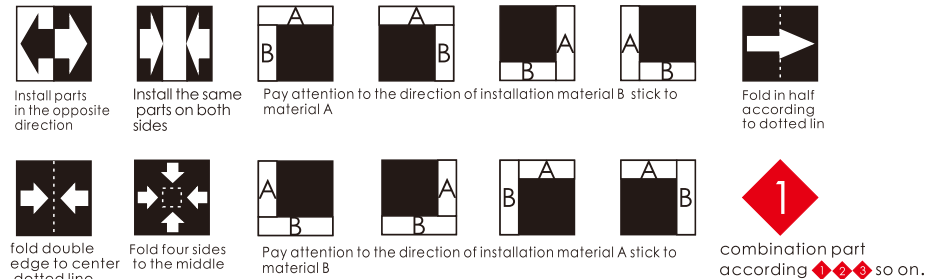

## About the use of glue

Method for using glue:  
 1. After applying the glue, let it dry for a few seconds before pasting.  
 2. Fix it slightly with your hands, and finally put it aside to dry;

### Types of glue:

White latex: Used for adhering soft materials, such as wood and paper.  
 Alcoholic Glue: Used for adhering hard materials such as cloth, plastic, beads, wire, dust cover, etc.

### Tips:

When pasting the plane printing paper, a piece of waste bank card or telephone card can be used to wipe evenly after the glue is smeared on the wood board, and then the printing paper is pasted to squeeze out the air inside.

Cut out N01 and N04 according to the template paper before making

Dining table

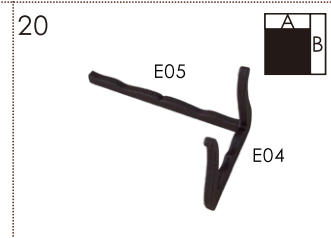
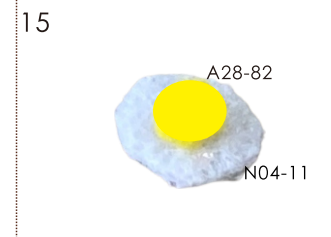
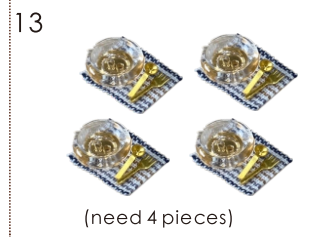
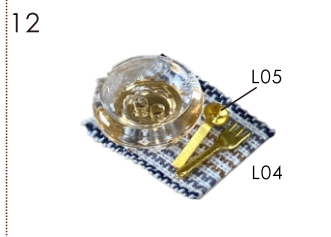
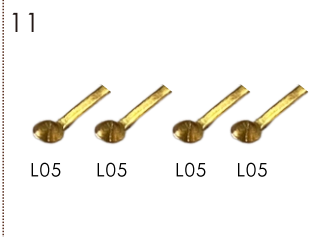
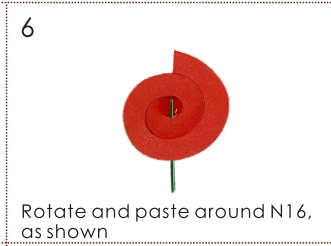
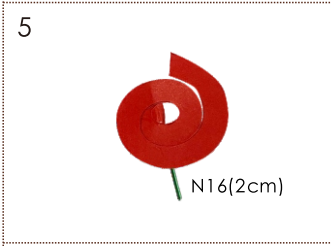
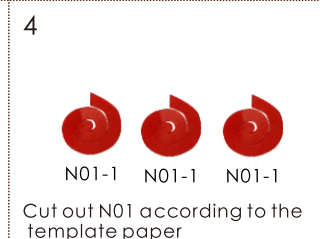
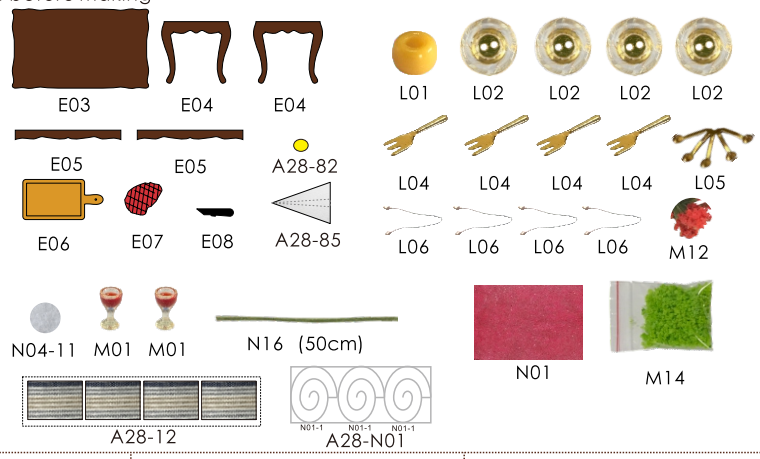

Dining chair

Cut out A26-9 and A26-10 from A26, and cut out N02 according to the template paper before making

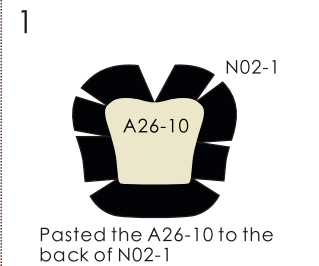
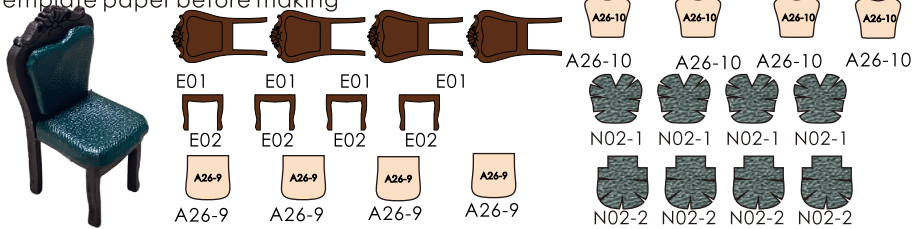

Cut out A27-1 to A27-4 from A27, and cut out N03 and N04 according to the template paper before making

Sofa

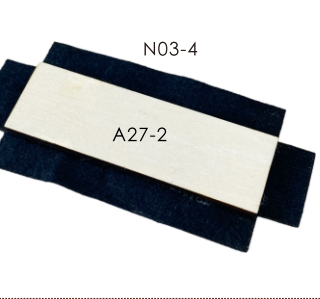
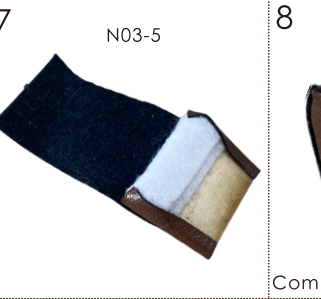
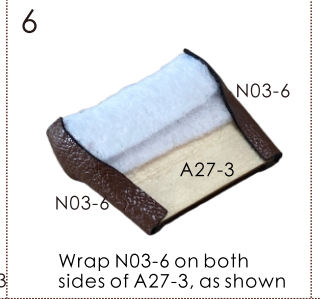
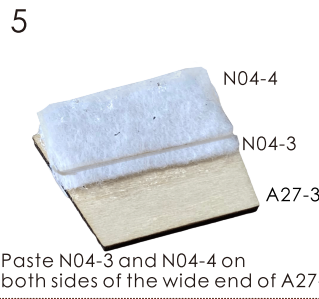
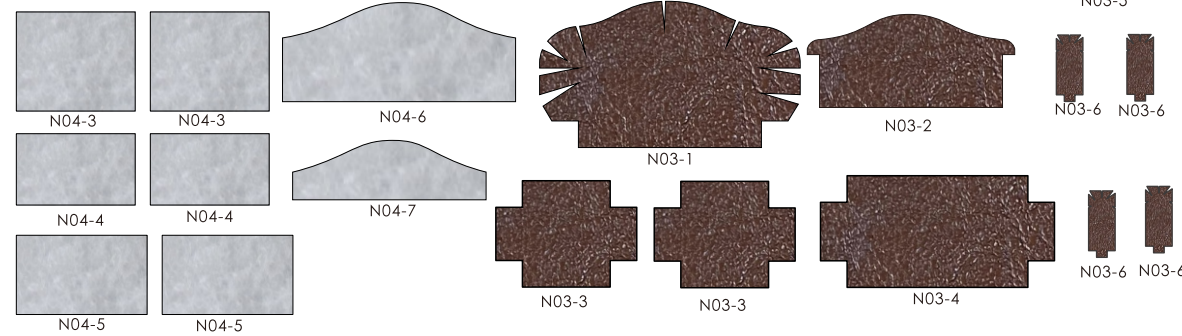
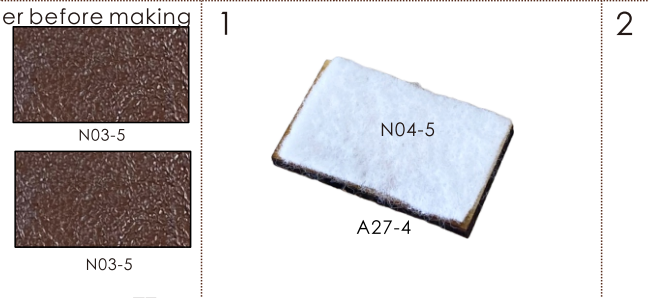
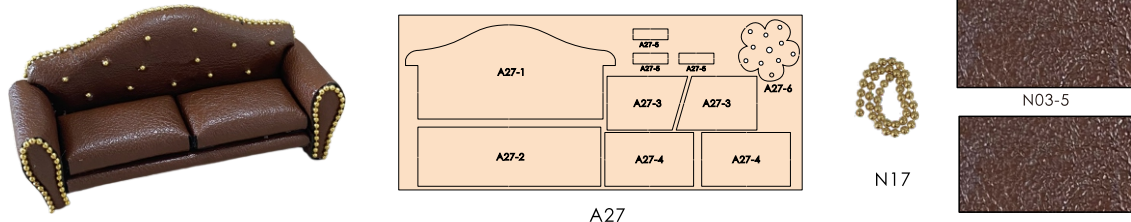

<p>10</p>  <p>Wrap A27-2 with N03-4</p>	<p>11</p>  <p>N04-6 A27-1</p>	<p>12</p>  <p>N04-7</p>	<p>13</p>  <p>N03-1 A27-1(backside)</p>	<p>14</p> 
<p>15</p>  <p>Trim off the excess</p>	<p>16</p>  <p>N03-2 Pasted N03-2 on the backside</p>	<p>17</p>  <p>1 1 3</p>	<p>18</p>  <p>4 2</p>	<p>19</p> 
<p>20</p>  <p>2</p>	<p>21</p>  <p>N17(8.4cm) N17(4.5cm) Pasted N17 as shown</p>	<p>22</p>  <p>Cut out about 13 pieces of N17, and pasted them as shown</p>	<p>23</p> 	
<p>Coffee table</p> 	 <p>F01 F02 F03 F04 A29-4 L07 L08 M02 M03 M04</p>	<p>1</p>  <p>F02 F02 F01</p>	<p>2</p>  <p>F04 F03</p>	<p>3</p>  <p>A29-4 L07 Use A29-4 to paste to L07</p>
<p>4</p> 	<p>5</p> 	<p>6</p>  <p>M04 M04 L08</p>	<p>7</p> 	<p>8</p>  <p>M02 M03</p>

<p>Desk</p> 	<p>1</p>  <p>Cut in half the N18</p>	<p>2</p>  <p>A28-17</p>
<p>3</p>  <p>A28-17</p>	<p>4</p>  <p>Cut N19 length 3.8cm, and bend it as shown</p>	<p>5</p> 
<p>9</p>  <p>L09</p>	<p>10</p>  <p>L10 N17: 1.5cm</p>	<p>11</p> 
<p>15</p>  <p>F12</p>	<p>16</p>  <p>F11</p>	<p>17</p>  <p>F14 F13</p>
<p>21</p>  <p>F15</p>	<p>22</p> 	<p>18</p>  <p>F14 F13</p>
<p>1</p>  <p>A28-39 H11</p>	<p>2</p> 	<p>3</p>  <p>H14 H12</p>
<p>6</p>  <p>N19(3.5cm) M17 0.3cm</p> <p>Cut N19 length 3.5cm and bend it as shown</p>	<p>7</p>  <p>0.3cm L10</p> <p>Bend it as shown</p>	<p>8</p>  <p>Bend the N19 as shown</p>
<p>12</p>  <p>A28-22</p>	<p>13</p> 	<p>4</p>  <p>H14 H14</p>
<p>19</p>  <p>F16 F16</p>	<p>20</p>  <p>F13 F13</p>	<p>Sink</p>  <p>A28-39 H11 H14 H14</p>
<p>5</p>  <p>H13</p>	<p>6</p>  <p>H13 H13</p>	<p>5</p>  <p>H13 H13</p>

<p style="writing-mode: vertical-rl; transform: rotate(180deg);">BOOKCASE</p> 	<p>Cut out A26-6 from A26 before making</p> 	<p>1</p> 	<p>2</p> 	<p>3</p> 	<p>4</p> 
<p>5</p> 	<p>6</p> 	<p>7</p> 	<p>8</p>  <p>Fold by structure line</p>	<p>9</p>  <p>According to the previous steps, complete other book collections with the same structure</p>	<p>10</p>  <p>Fold by structure line</p>
<p>11</p>  <p>According to the previous steps, complete the remaining 3</p>	<p>12</p>  <p>Place the books as shown</p>	<p style="writing-mode: vertical-rl; transform: rotate(180deg);">Exercise bike</p> 	<p>1</p> 	<p>2</p> 	
<p>3</p> 	<p>4</p> 	<p>5</p> 	<p>6</p>  <p>0.6cm 0.2cm N19:0.8cm (Need 2 pieces)</p>	<p>7</p> 	<p>8</p> 
<p style="writing-mode: vertical-rl; transform: rotate(180deg);">Pillows</p> 	<p>Cut out N05 according to the template, and N11 and N12 according to the size on the picture before making</p> 	<p>1</p>  <p>Fold the cloth in half and glue the three sides, as shown</p>	<p>2</p>  <p>Stuff the right amount of N15 cotton</p>	<p>3</p>  <p>After the cotton is plugged, seal the gap</p>	<p>4</p>  <p>According to the previous steps, make other pillows</p>

European bed

Cut out A26-5 and A26-8 from A26, and cut out N04 according to the template paper before making

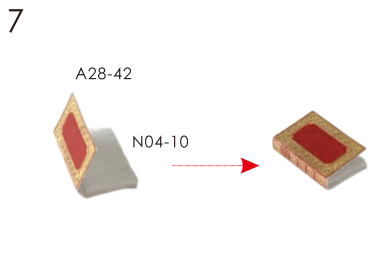
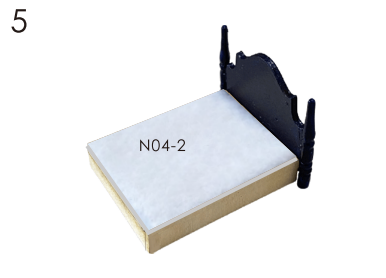
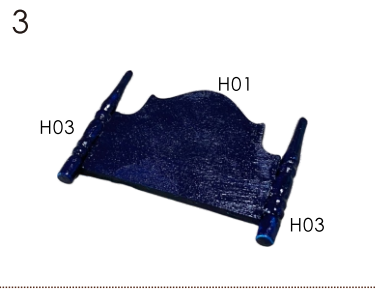
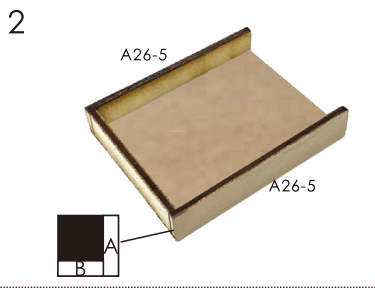
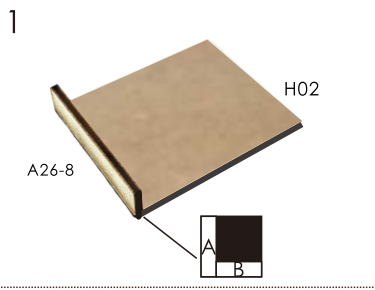
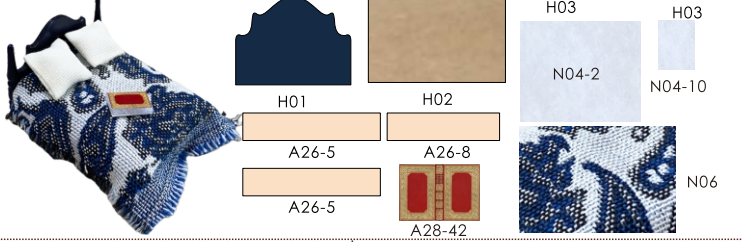

Chinese bed



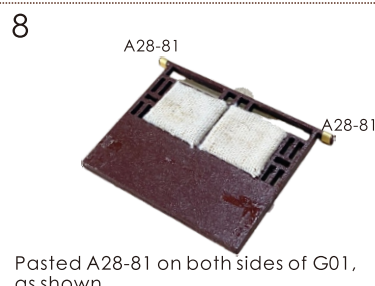
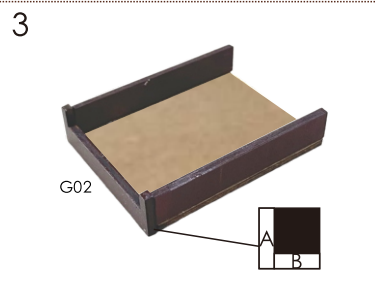
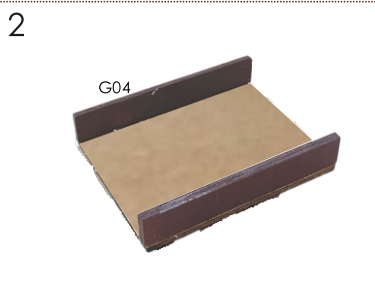
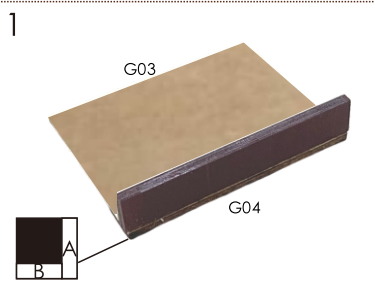
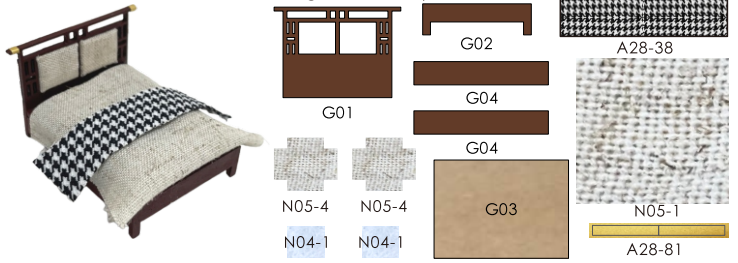





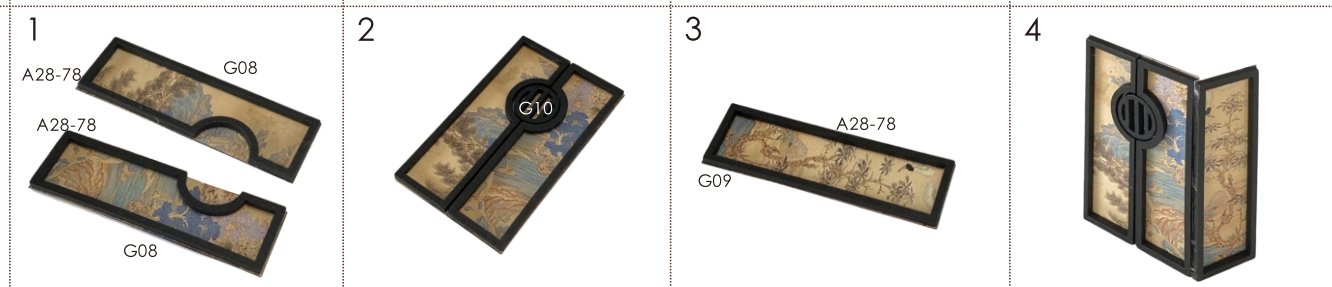
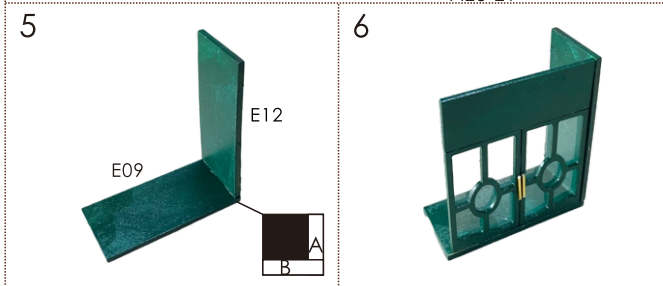
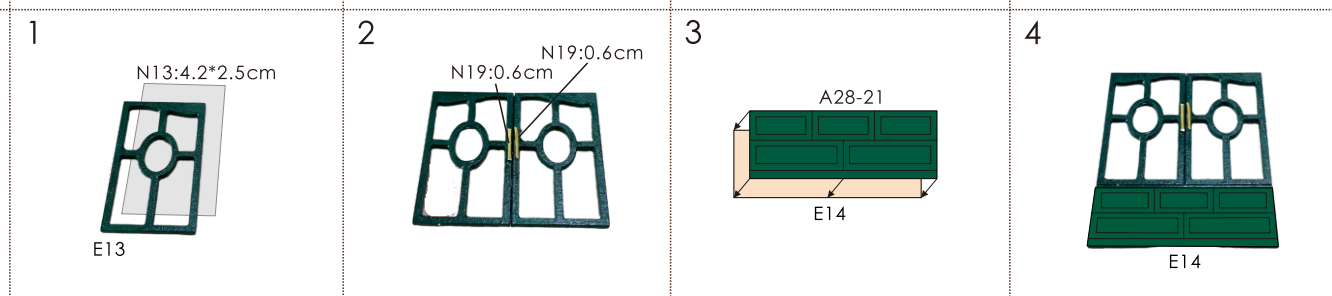
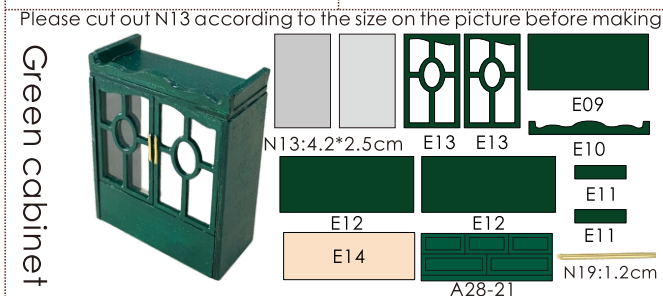
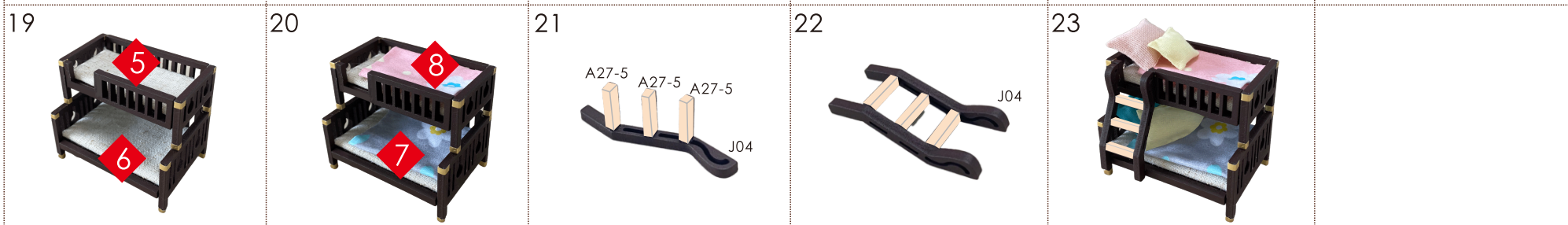





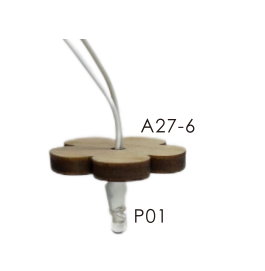
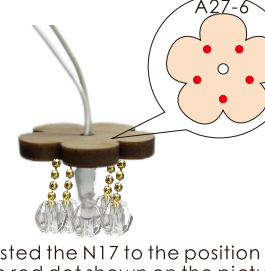
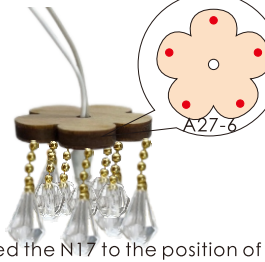
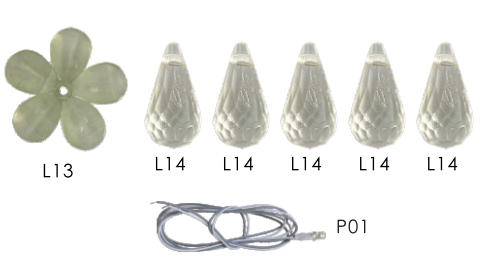
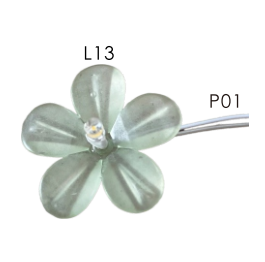





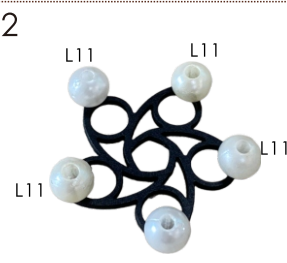

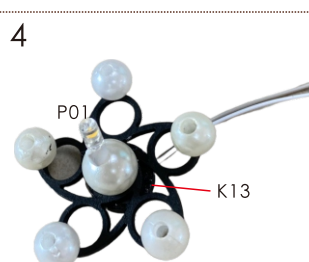
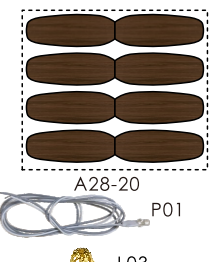

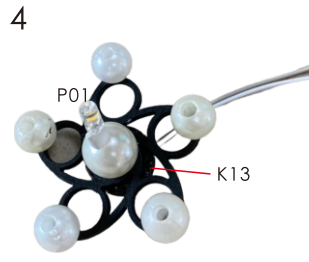

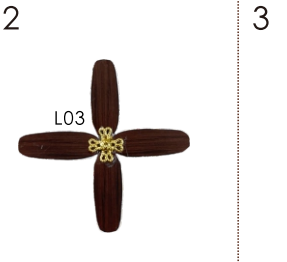
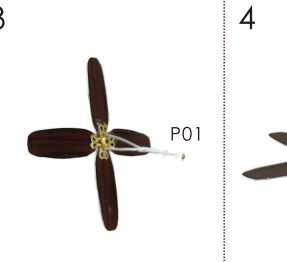
Please cut out N04 & N05 according to the template before making

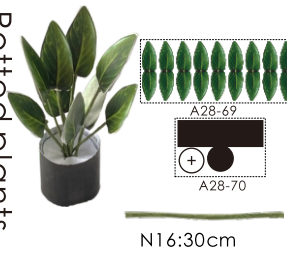
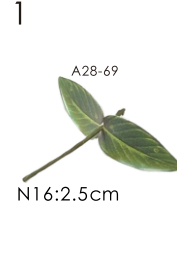

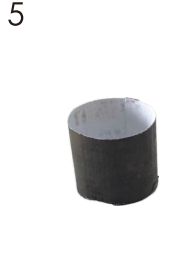

Side table	Cut out N04 according to the template paper before making.				
		1	2	3	4
5	6	7	8	9	10
Bunk bed	Cut out N04 and N05 according to the template paper, and deduct A27-5 from A27 before making				
		1	2	3	4
5	6	7	8	9	10
11	12	Fold the N09 as shown and pasted it			



<p><b>Chandelier 1</b></p> <p>Cut out A27-6 from A27 before making</p> <p>N17:10cm</p> <p>A27-6 L18(5 pieces)</p> <p>L19(5 pieces)</p> <p>P01</p> 	<p>1</p> <p>N17:1cm (Need 10 pieces)</p> <p>Cut N17 into 1cm</p> 	<p>2</p> <p>N17:1cm</p> <p>L18</p> 	<p>3</p> <p>N17:1cm</p> <p>L19</p> 	<p>4</p> <p>A27-6</p> <p>P01</p> 	<p>5</p> <p>A27-6</p> <p>Pasted the N17 to the position of the red dot shown on the picture</p> 			
<p>6</p> <p>A27-6</p> <p>Pasted the N17 to the position of the red dot shown on the picture</p> 	<p><b>Chandelier 2</b></p> <p>L13</p> <p>L14 L14 L14 L14 L14</p> <p>P01</p> 	<p>1</p> <p>L13</p> <p>P01</p> 	<p>2</p> <p>L14</p> 	<p>3</p> <p>L14</p> <p>L14</p> <p>L14</p> <p>L14</p> 	<p>4</p> <p>L14</p> 			
<p><b>Chandelier 3</b></p> <p>K12</p> <p>K13</p> <p>L11 L11 L11 L11 L11</p> <p>L12</p> <p>P01</p> 	<p>1</p> <p>K12</p> <p>L11</p> 	<p>2</p> <p>L11</p> <p>L11</p> <p>L11</p> <p>L11</p> <p>L11</p> 	<p>3</p> <p>L12</p> 	<p>4</p> <p>P01</p> <p>K13</p> 	<p><b>Chandelier 4</b></p> <p>A28-20</p> <p>P01</p> <p>L03</p> 			
<p>3</p> <p>L12</p> 	<p>4</p> <p>P01</p> <p>K13</p> 	<p>1</p> <p>A28-20</p> <p>Fold it in half</p> 	<p>2</p> <p>L03</p> 	<p>3</p> <p>P01</p> 	<p>4</p> 			
<p><b>Potted plants</b></p> <p>A28-69</p> <p>A28-70</p> <p>N16:30cm</p> 	<p>1</p> <p>A28-69</p> <p>N16:2.5cm</p> 	<p>2</p> 	<p>3</p> <p>N16:2.5cm*2</p> <p>N16:4cm*4</p> <p>N16:3cm*3</p> 	<p>4</p> <p>A28-70</p> 	<p>5</p> 	<p>6</p> <p>A28-70</p> 	<p>7</p> 	<p>8</p> 

Cut out N14 according to the template paper before making

Gate 1

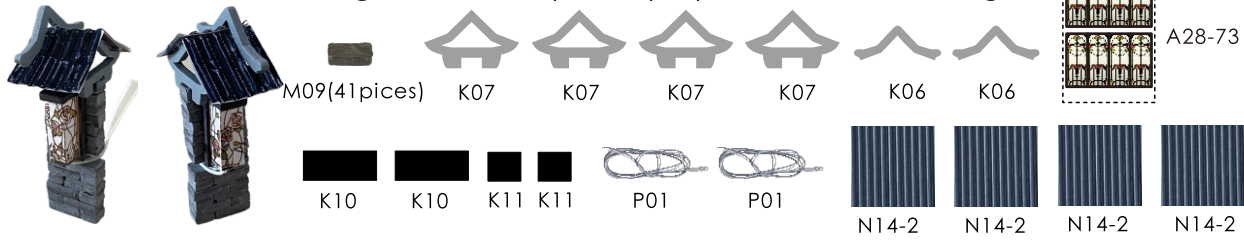

1



2



3

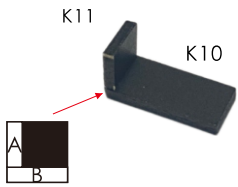

4



5

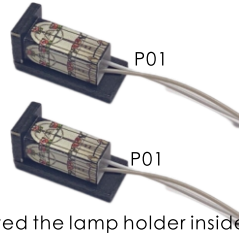

6

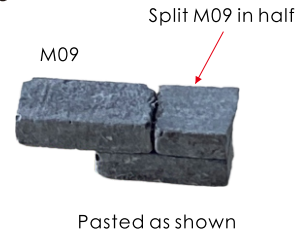

7



8



9



10



11



12



13



14

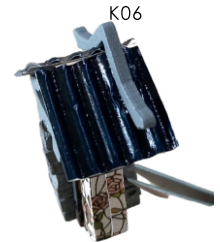

15



16



17



18

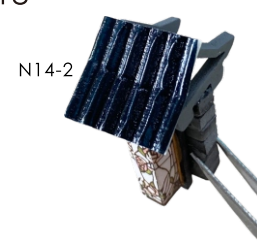

19

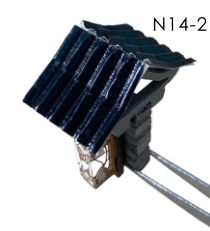

20



21



22



23



24



25



26



Cut out N14 according to the template paper before making

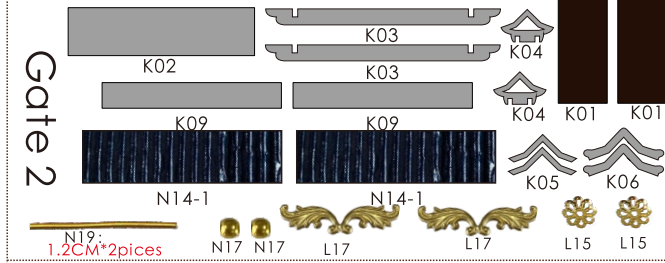

Gate 2

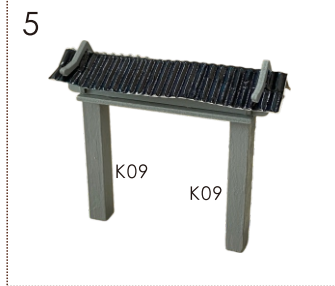
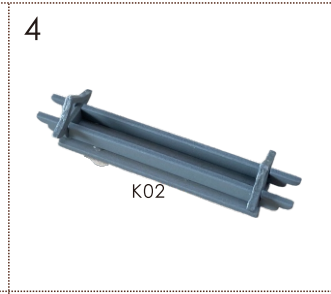
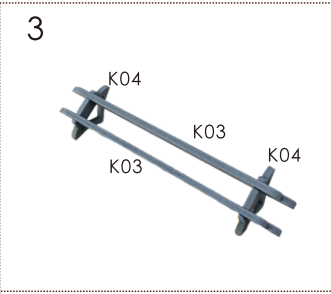
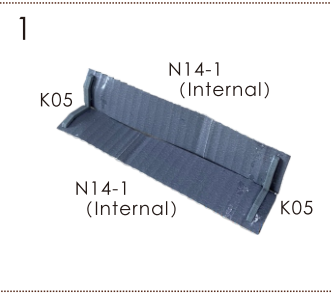

Fence

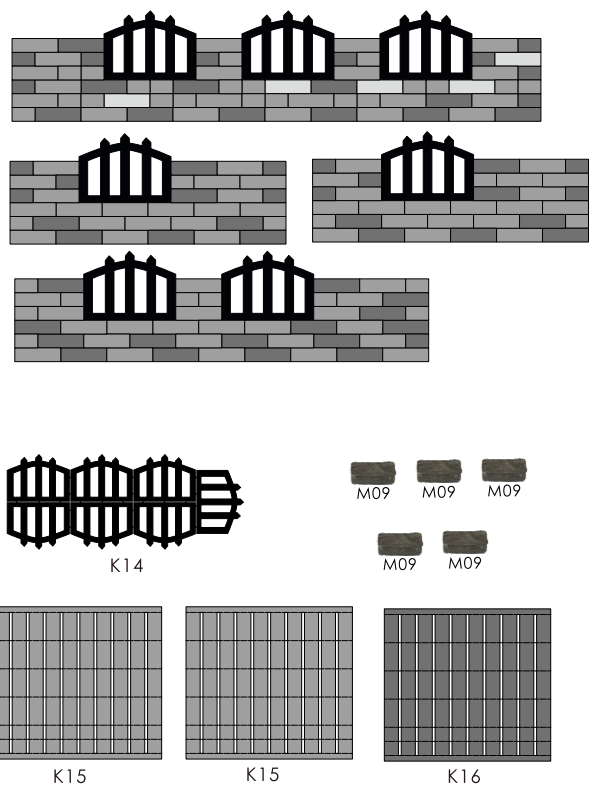

- 1 K15(Long block)
- 2 K15(Short block)
- 3 K16(Long block)
- 4 K16(Short block)
- 5 M09

As described in the figure above, K15, K16, M09 The way the colors represented are assembled on the wall.  
 Note: The colors shown in this step are mainly for distinguishing. It's not the real color! Please use according to the corresponding number

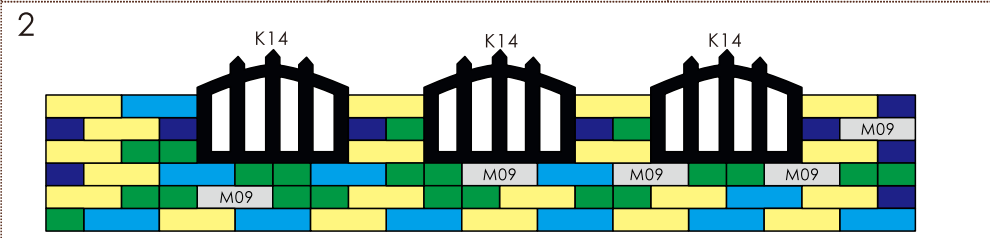

The picture above is a 1:1 front view. The K15, K16, K17, and M09 are sorted in intervals according to the picture above.

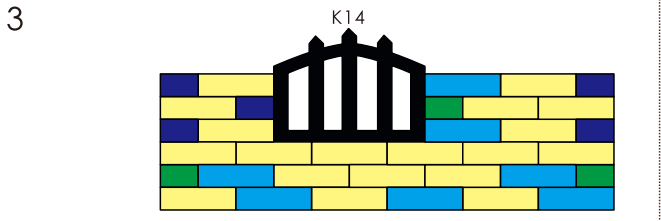

The picture above is a 1:1 front view, sorting K15, K16, K17 intervals Assemble and paste as shown in the figure above to complete.

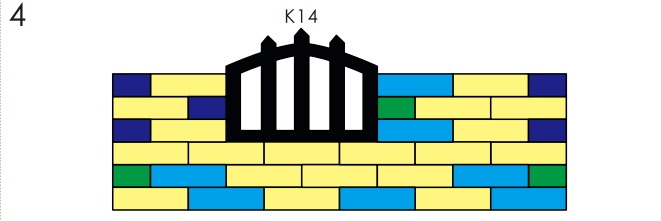

The picture above is a 1:1 front view, sorting K15, K16, K17 intervals Assemble and paste as shown in the figure above to complete.

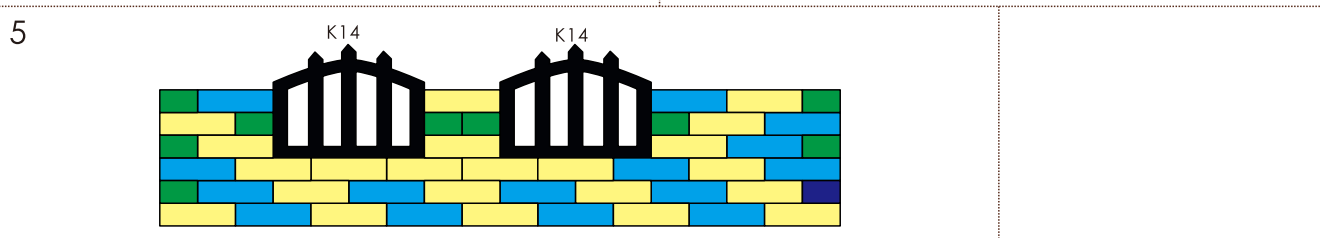

The above picture is a 1:1 front view. The K15, K16, K17 interval sorting is assembled and pasted according to the above picture.

Piano

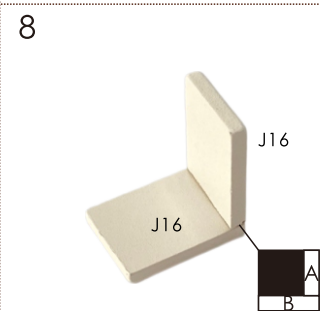
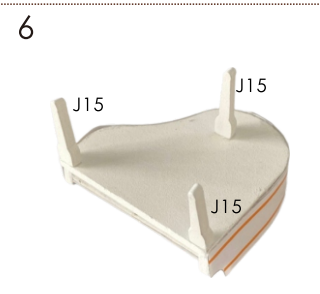
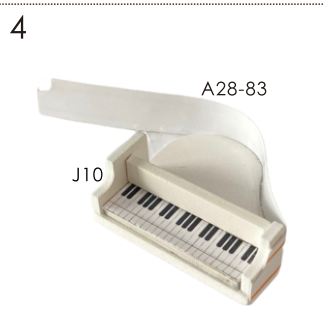
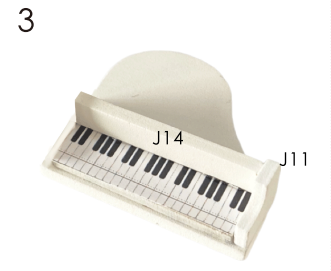
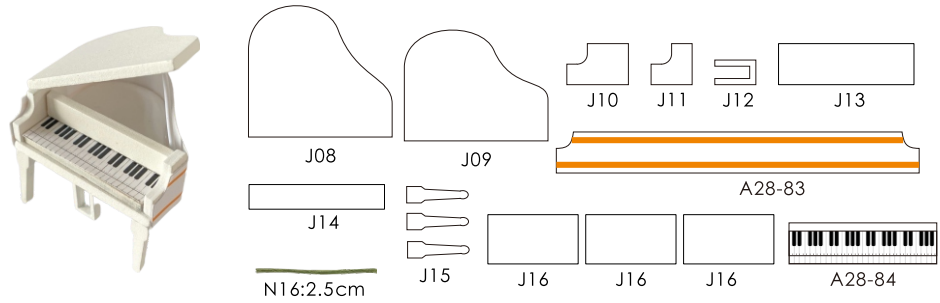

Chimney

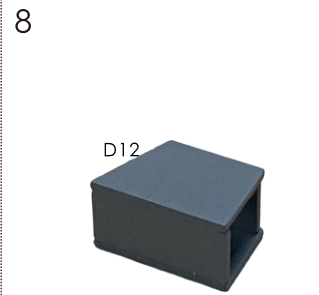
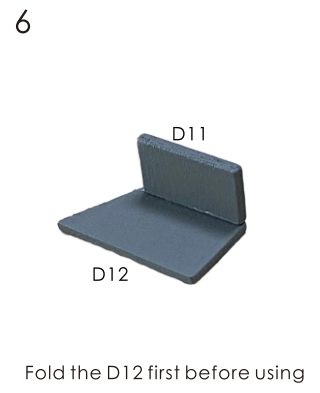
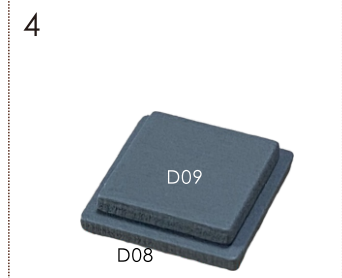
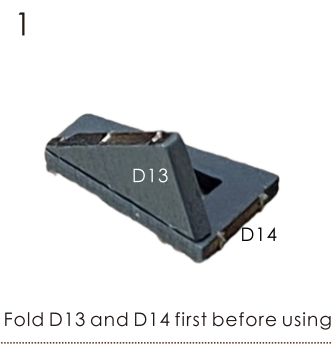
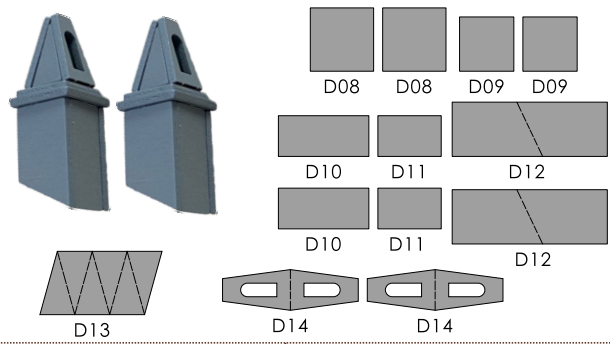

<p>Lighthouse &amp; Small spire</p> <p>D01 D01 D01 D02  D03 D03 D03 D03 D04 D04 D04  D05 D05 D06 D06 D06 D06 D07 D07 D07 D07  D05 D05  D18 D18 D18 D18 P01 P01</p>	<p>1</p> <p>D06 D07</p>	<p>2</p> <p>D05</p>	<p>3</p> <p>D18 D18 D03 Before making, fold the D18 first before using</p>		
	<p>4</p> <p>D18 D18</p>	<p>5</p> <p>D18</p>	<p>6</p> <p>Make 4 pieces</p>		
<p>7</p> <p>P01</p>	<p>8</p> <p>D01 D04 Before making, fold the D01 first before using</p>	<p>9</p> <p>D01</p>	<p>10</p> <p>D01</p>	<p>11</p> <p>D01</p>	<p>12</p>
<p>13</p> <p>Make 3 pieces</p>	<p>14</p> <p>D02</p>	<p>15</p>	<p>16</p> <p>Finished</p>	<p>Bird house</p> <p>A26-1 A26-2 A26-3 A26-3 A28-08 A28-09  E15 E16 E16 P01 A28-10 A28-11</p>	
<p>1</p> <p>A26-1 P01</p>	<p>2</p> <p>A28-09 back side A26-2 E15 A28-08</p>	<p>3</p> <p>A26-3 A28-10</p>	<p>4</p> <p>A28-11</p>	<p>5</p> <p>E16</p>	<p>6</p> <p>E16</p>

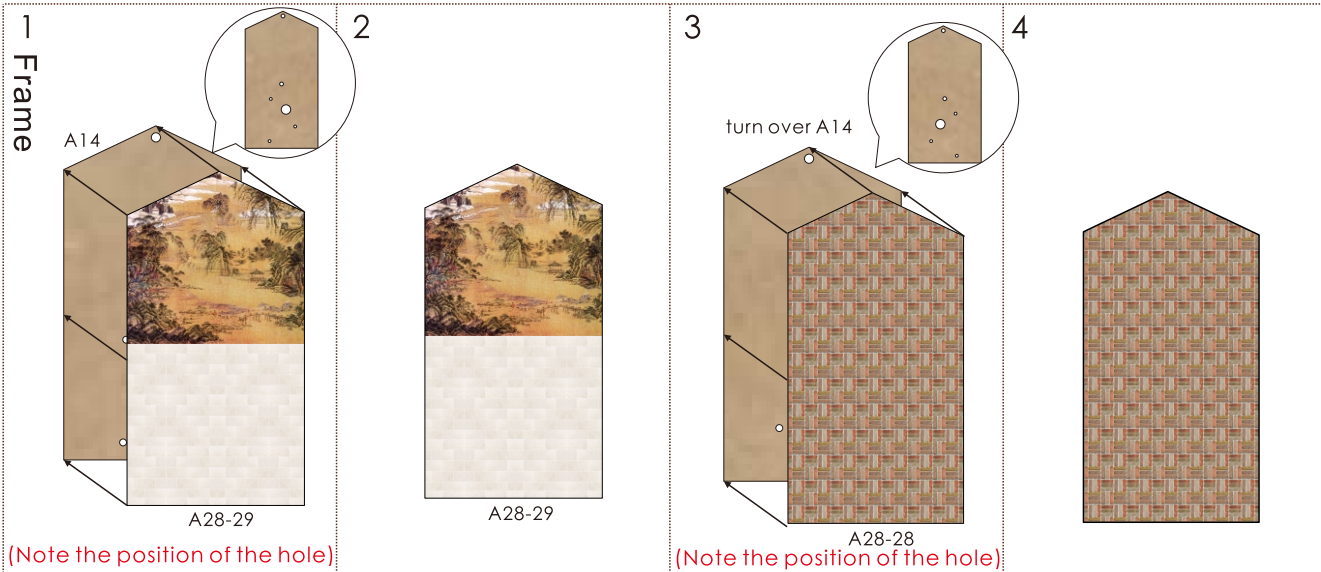

(Note the position of the hole)

(Note the position of the hole)

Upgraded accessories  
(Need to purchased separately)

Q01 musical movement (1 piece)

Q02 musical movement screw (3 pieces)

Q03 musical movement handle (1 piece)

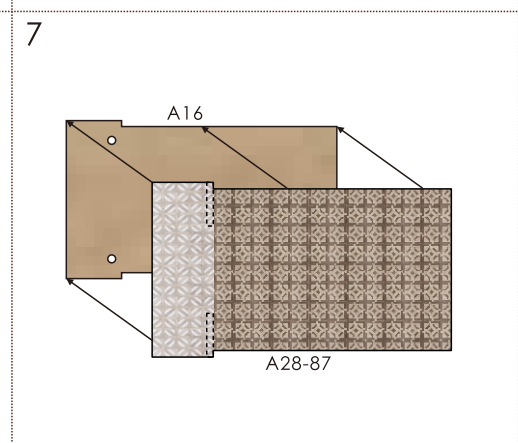
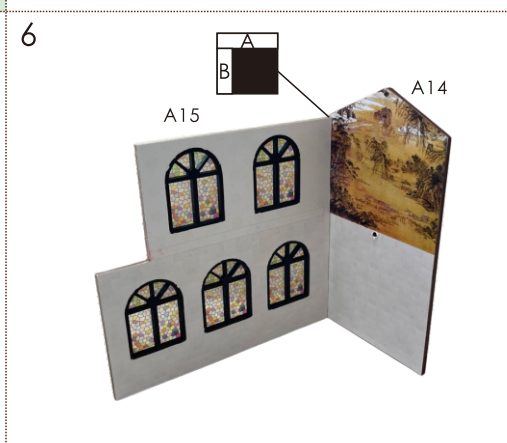
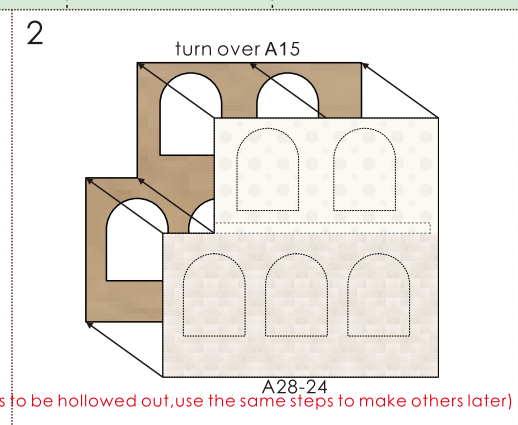
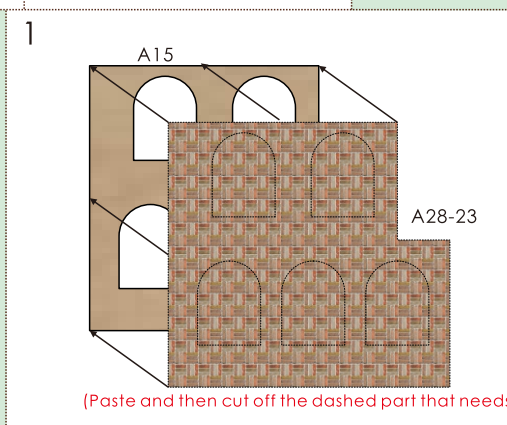
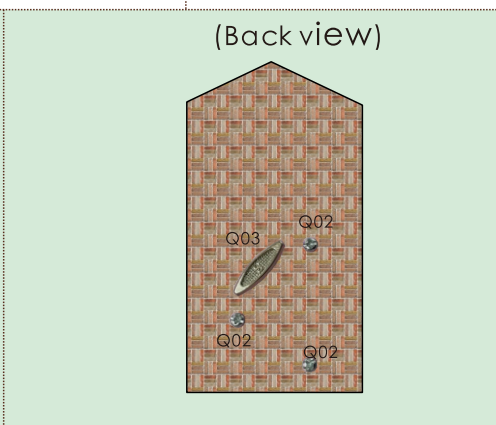
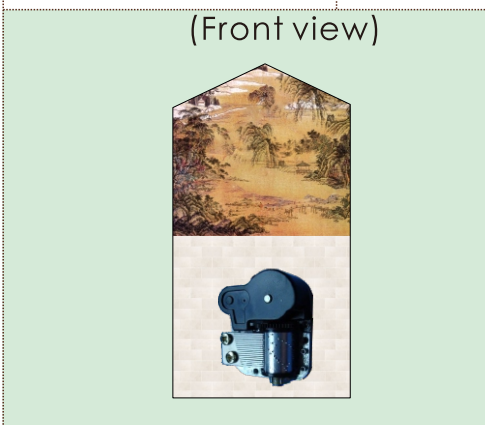

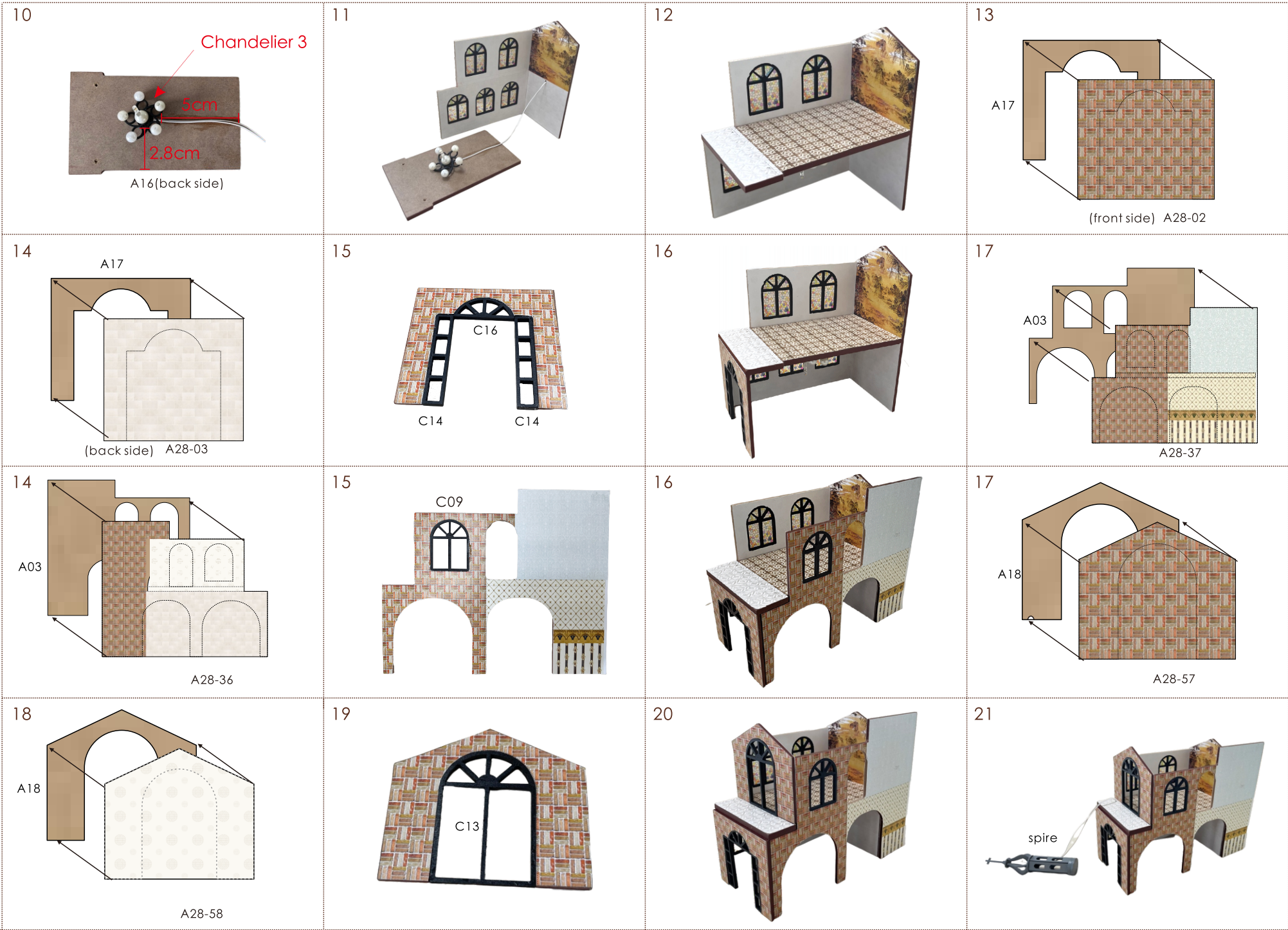

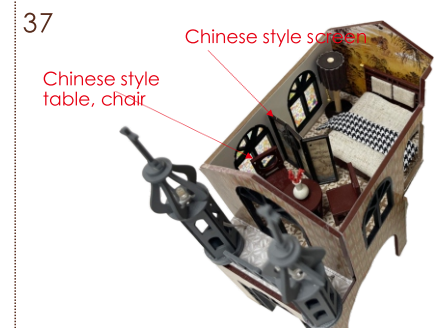
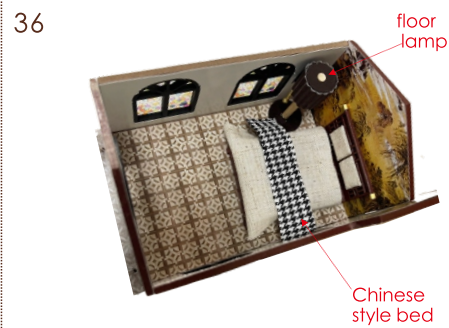
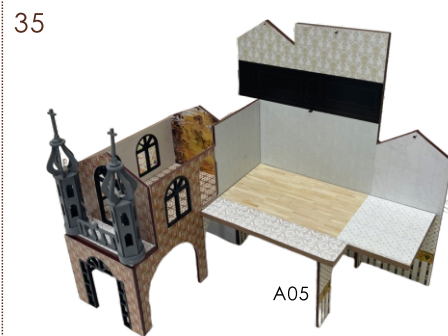
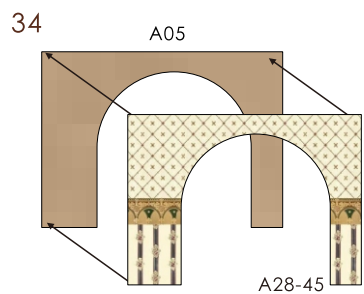
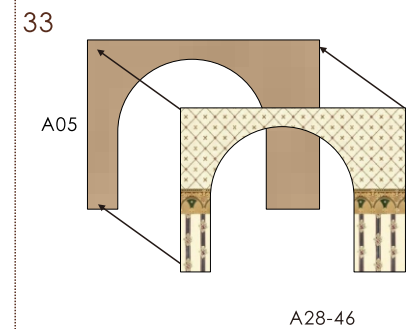
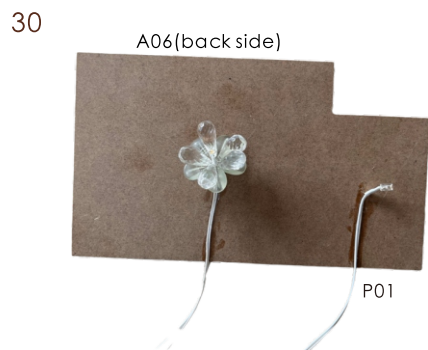
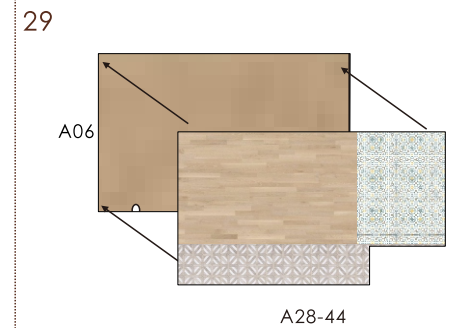
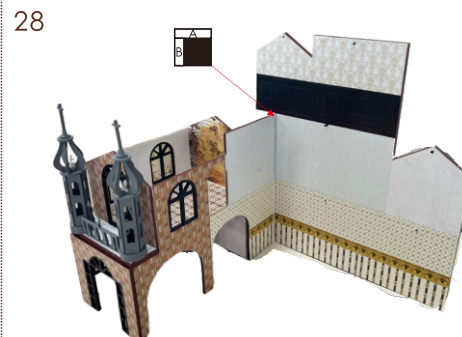
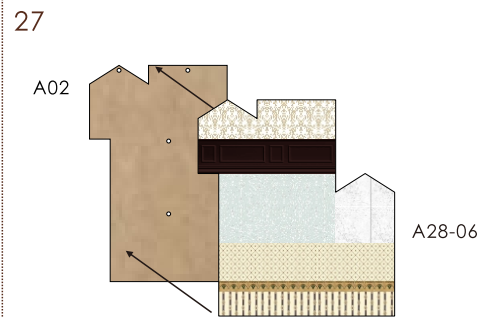
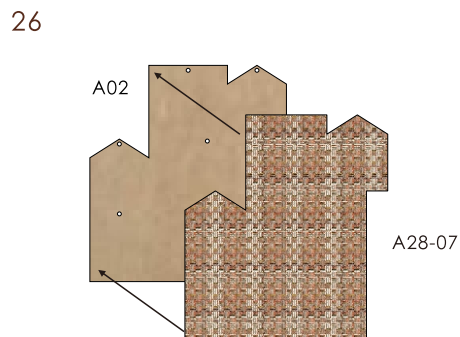
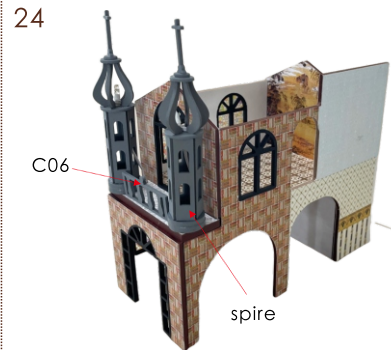
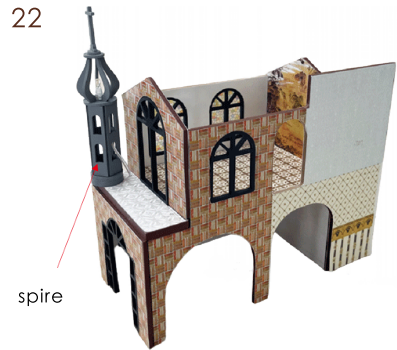

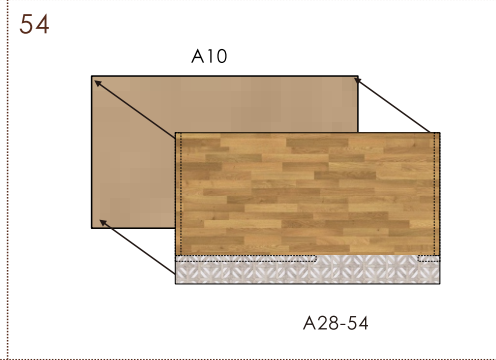
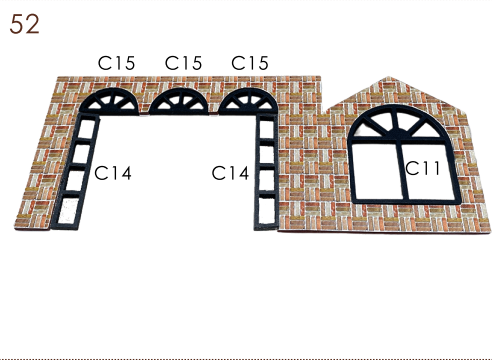
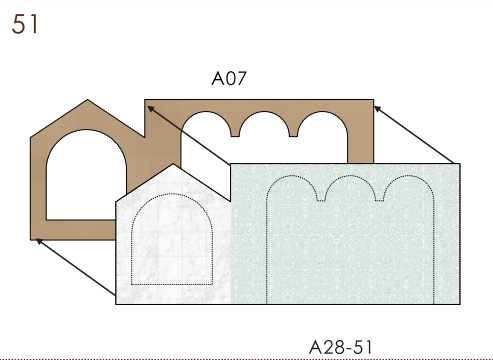
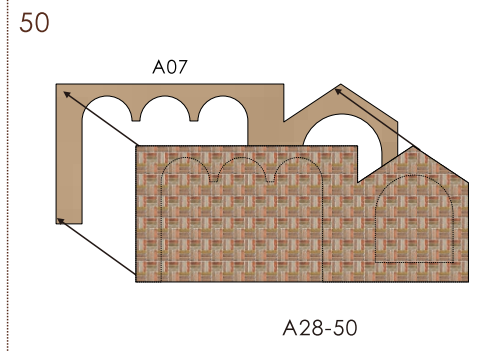
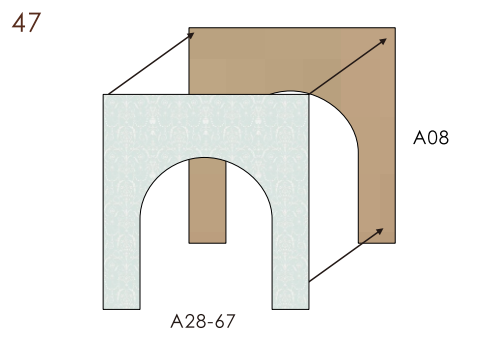
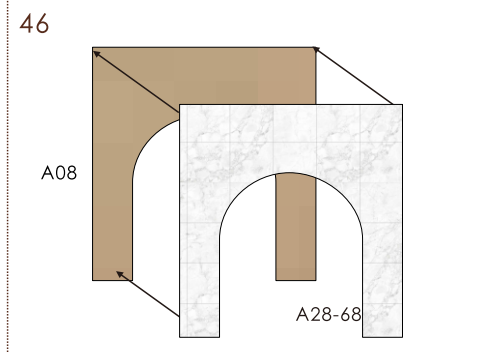
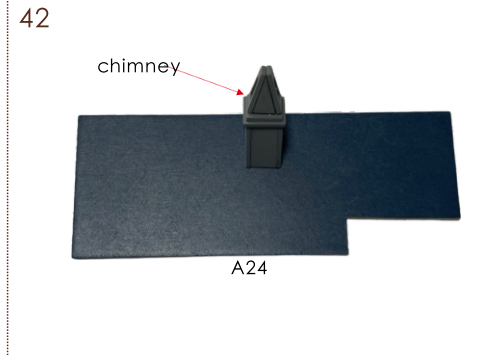
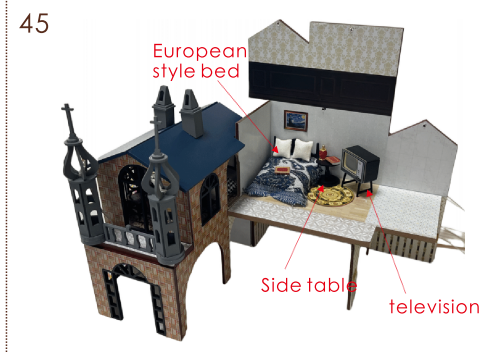
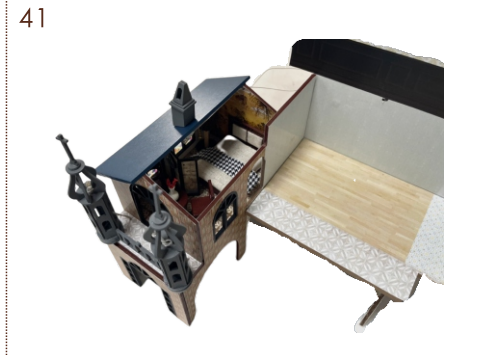
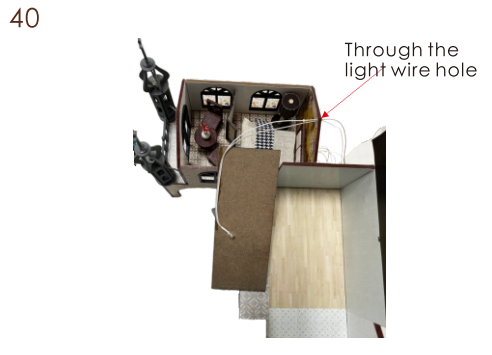
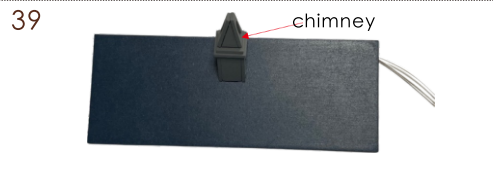
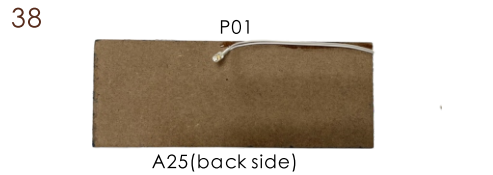



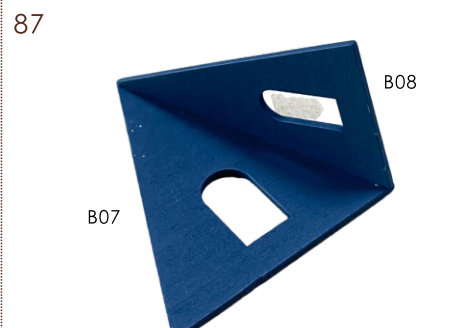
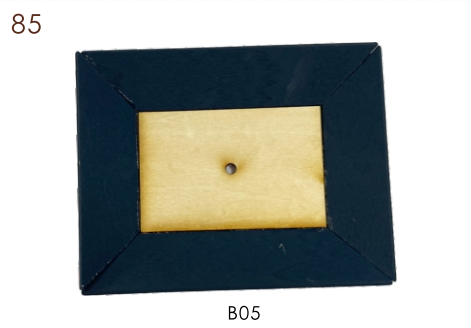
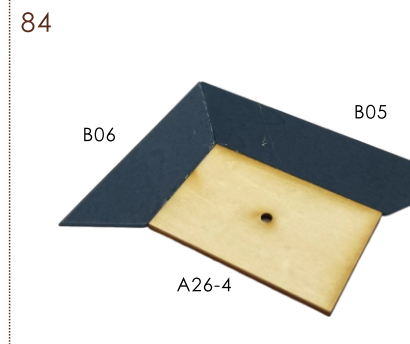
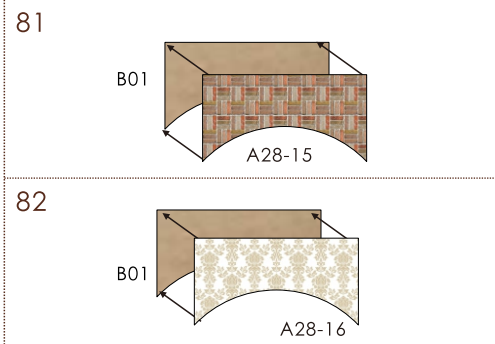
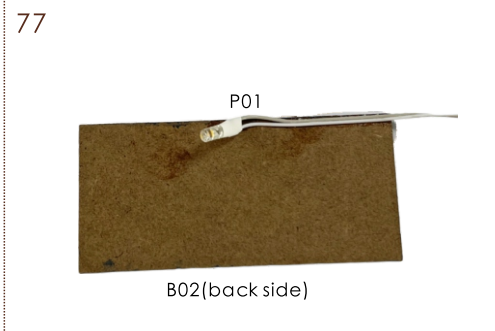
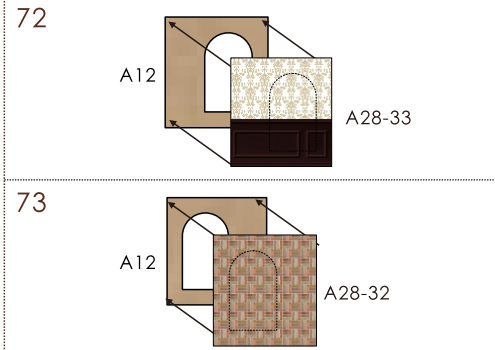
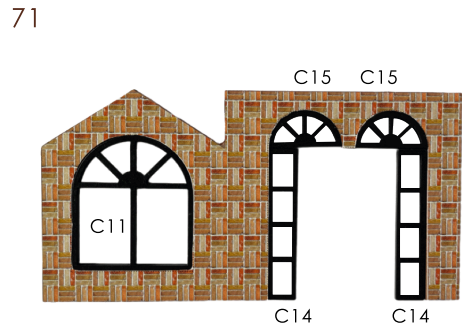

89

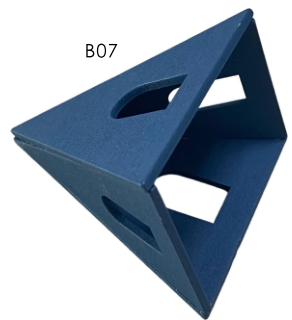

90

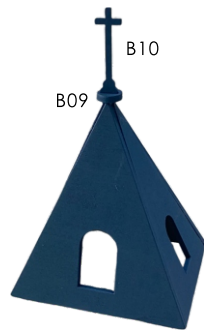

91



92



93



94



95



96



97



98



99



100



101



102

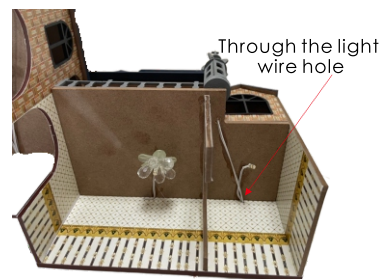

103

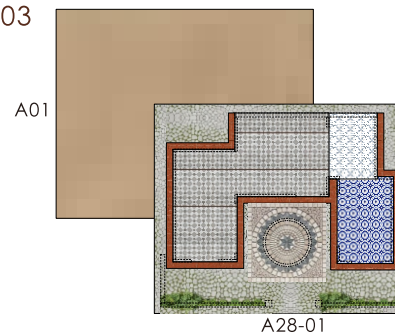

104



105



106



107



108



109



110



111



112



113



114

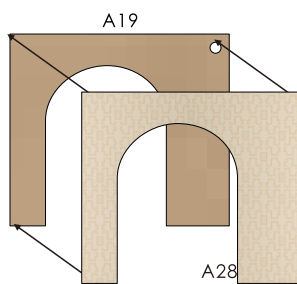

115

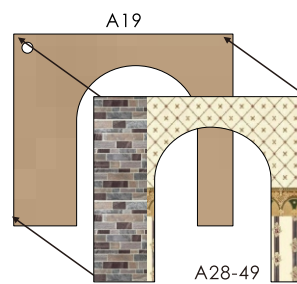

116



117

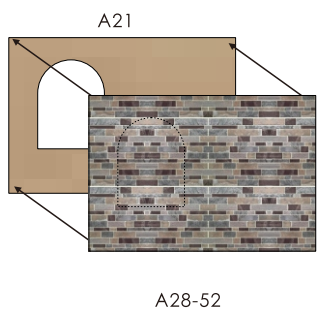

118

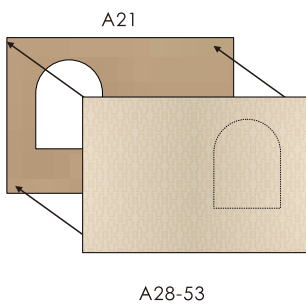









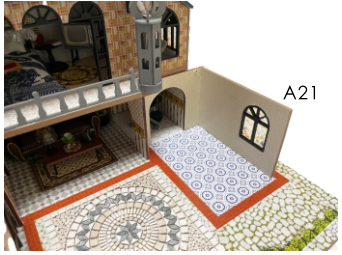

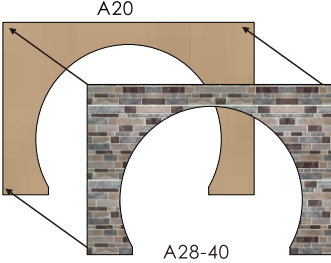
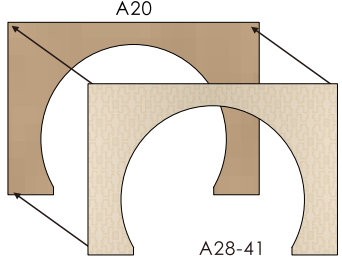
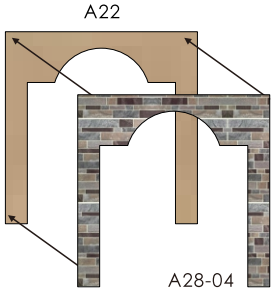
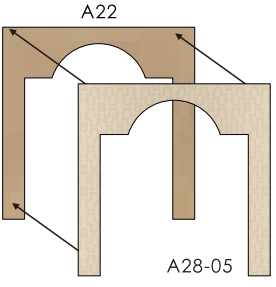
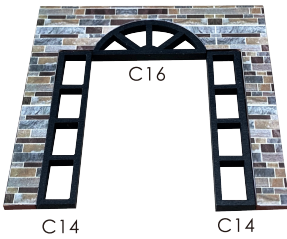
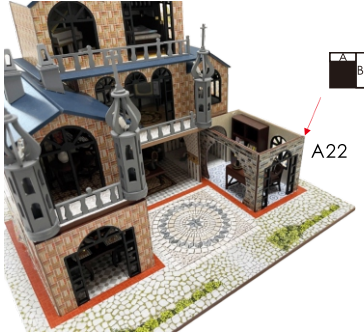

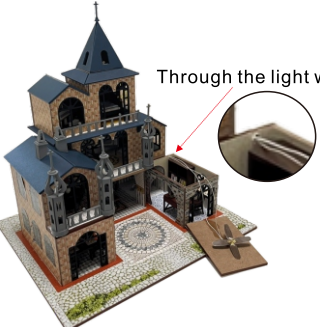

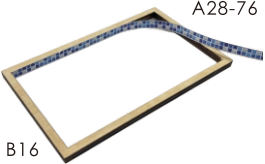

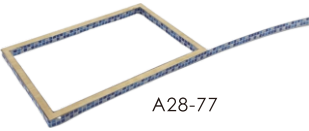
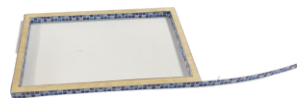
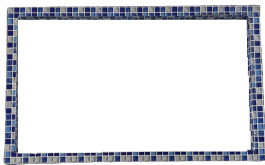

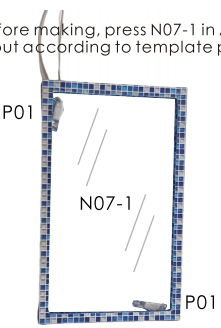
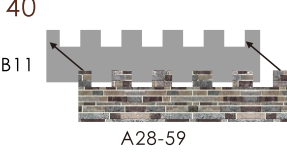
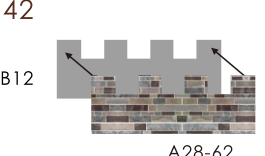
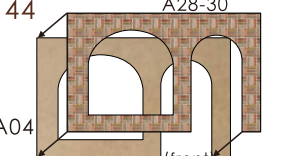

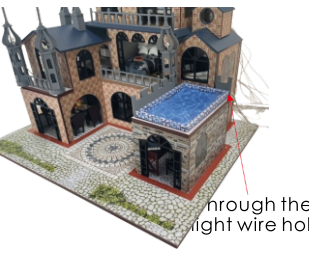
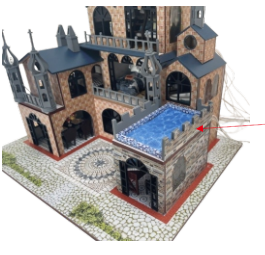

119

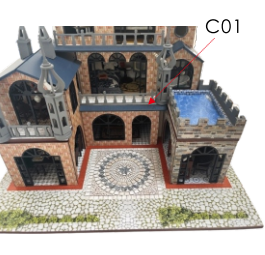

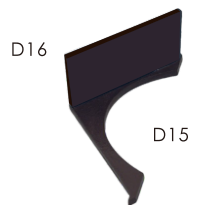
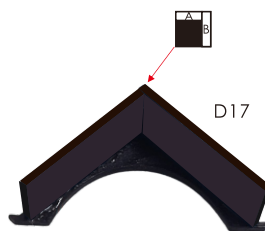
120

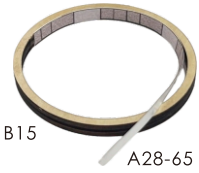

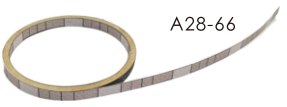
<p>121</p> 	<p>122</p>  <p>bookcase chair desk</p>	<p>123</p>  <p>A20 A28-40</p>	<p>124</p>  <p>A20 A28-41</p>		
<p>125</p>  <p>A22 A28-04</p>	<p>126</p>  <p>A22 A28-05</p>	<p>127</p>  <p>C16 C14 C14</p>	<p>128</p>  <p>A22</p>		
<p>129</p>  <p>A23 A28-75</p>	<p>130</p>  <p>A23(backside) Chandelier4</p>	<p>131</p>  <p>Through the light wire hole</p>	<p>132</p> 		
<p>133</p>  <p>A28-76 B16</p>	<p>134</p> 	<p>135</p> 	<p>136</p>  <p>A28-77</p>	<p>137</p> 	<p>138</p>  <p>A28-74</p>

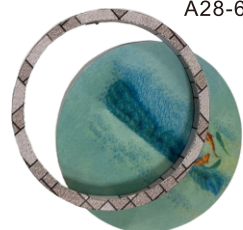
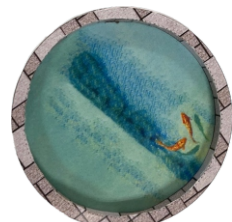
<p>139 Before making, press N07-1 in A11 Cut out according to template paper</p> 	<p>140</p> 	<p>142</p> 	<p>144</p> 	<p>145</p> 	<p>146</p> 
<p>147</p> 	<p>148</p> 	<p>149</p> 	<p>150</p> 	<p>151</p> 	<p>152</p> 
<p>153</p> 	<p>154</p> 	<p>155</p> 	<p>156</p> 	<p>157</p> 	<p>158</p> 
<p>159</p> 	<p>160</p> 	<p>161</p> 	<p>162</p> 	<p>163</p> 	<p>164</p> 

165 Before making, cut out N07-2 according to the template paper in A11

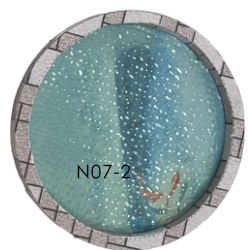

166



167



168



169

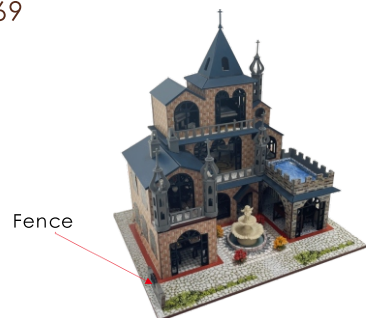

170

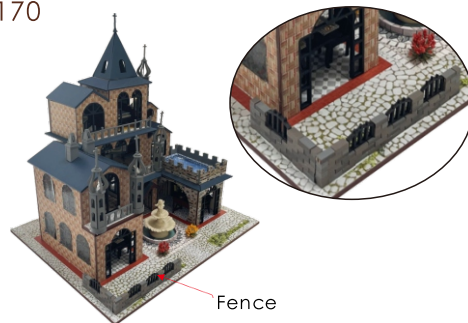

171

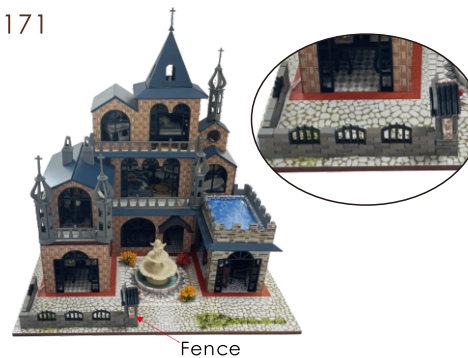

172



173



174



175



176



177



178



179



180



181



182



Paste an appropriate amount of M14 as the photo shown

183



Paste an appropriate amount of M14 as the photo shown

184



### How to assemble the battery holder

Statement:  
the lamp wires cannot be inserted into the output socket.

- Can use 2\*AAA batteries
- Please notice the place of anode and cathode when put in the batteries
- Rechargeable batteries are not blunt electricity
- Rechargeable batteries can only be charged under adult supervision
- Rechargeable batteries should be removed from the toy before charging
- Different types of batteries cannot mix;
- Do not mix new batteries in use with semi-used batteries.
- Run out of battery should be removed from the toy
- The power shall not be short circuit

1



Concentrate all the light wires to the back

2



Cut all light wires to the same length

3



Strip the outer skin of the lamp wire and twist it together

4



Connect the red wire of the battery box to the gray wire of the LED light.  
Connect the black wire of the battery box to the white wire of the LED light.  
Connect separately (make sure the LED bulb can light up)

5



Wrap the light wire connection with P03

# Installation of dust cover

dust cover  
(Upgrade version accessories need to be purchased separately)



scale 1:12  
Z01 plexiglass (transparent)  
32\*26\*0.18 (1 piece)

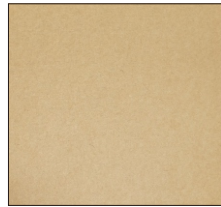

scale 1:12  
Z02 plexiglass (transparent)  
34\*32\*0.18 (2 pieces)



scale 1:12  
Z03 plexiglass (transparent)  
34\*25.64\*0.18 (2 pieces)

1

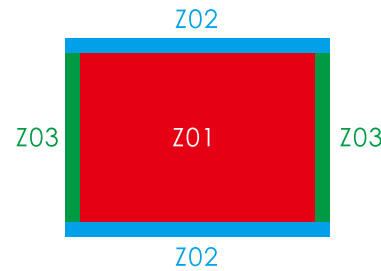

stick Z01 and Z02 on Z03

2

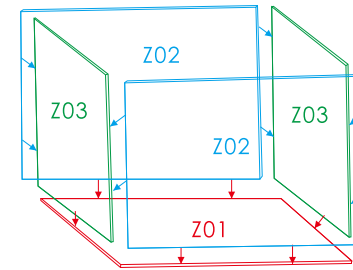

stick five pieces of plexiglass dust cover as shown

3

Ripped one side of kraft paper, leaving one side of kraft paper



Take out the plexiglass and tear off the kraft paper with text on each piece of plexiglass

4

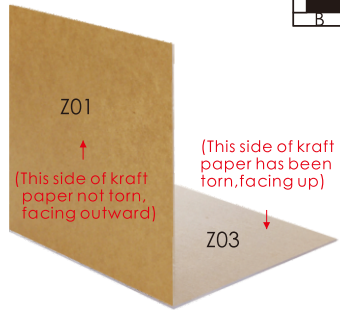

The kraft paper that has been ripped out faces inwards, and the kraft paper that has not been ripped out faces outwards.

5

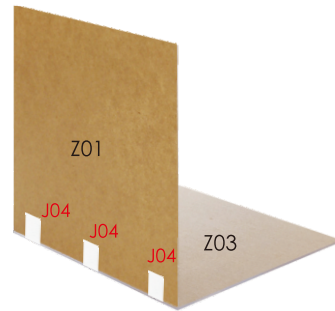

Use J04 to fix the junction of two pieces of plexiglass, (use transparent tape to replace J04).

6

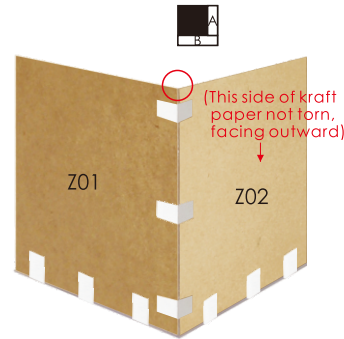

The junction of every two pieces of plexiglass needs to be fixed with J04 (to prevent the plexiglass falling off)

7

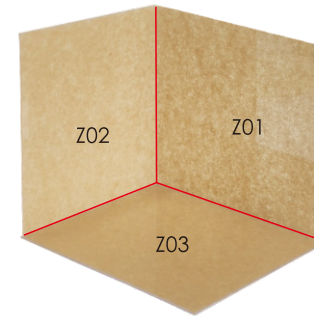

stick appropriate amount of glue to the interface of the two pieces of glass and scrape it slightly to make the glue penetrate into the junction of the two pieces of glass (the red line is the plexiglass interface)

8



The junction of two pieces of plexiglass needs to be fixed with J04 (to prevent the plexiglass falling off)

9

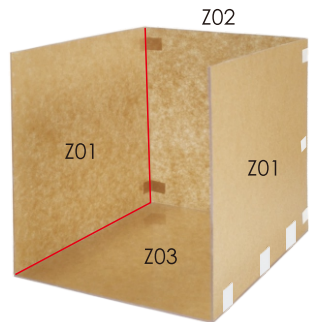

stick appropriate amount of glue to the interface of the two pieces of glass and scrape it slightly to make the glue penetrate into the junction of the two pieces of glass (the red line is the plexiglass interface)

10



The junction of two pieces of plexiglass needs to be fixed with J04 (to prevent the plexiglass falling off)

11

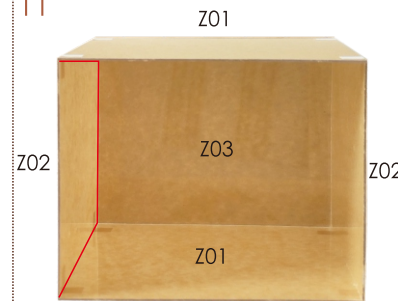

stick appropriate amount of glue to the interface of the two pieces of glass and scrape it slightly to make the glue penetrate into the junction of the two pieces of glass (the red line is the plexiglass interface)

12

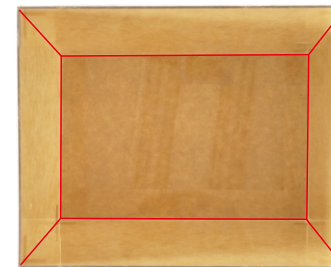

the dust cover need to be glued 8 interfaces

13

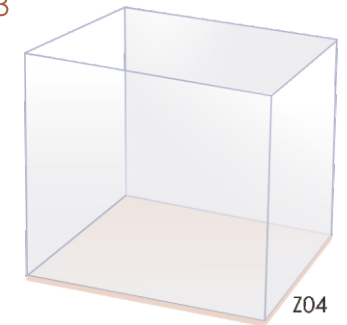

Leave it for 1 hour. After the glue dries out, tear off a layer of kraft paper outside the plexiglass

# Product Show





The instruction manual should be keep after assembled